

# Gigabit Media Converter with OAM Feature

<sup>1</sup>Nataraj R , <sup>2</sup>Ms .T.Sheela <sup>3</sup>Dr .T Muthumanickam, S.Kalaivani<sup>4</sup>

P.G. Student, Department of ECE, VMRF Deemed University Salem, Tamilnadu, India<sup>1</sup>

Associate Professor, Department of ECE, VMRF Deemed University Salem, Tamilnadu, India<sup>2</sup>

Professor, Department of ECE, VMRF Deemed University, Salem, Tamilnadu, India<sup>3</sup>

Assistant Professor, Department of ECE VMRF Deemed University, Salem, Tamilnadu, India<sup>4</sup>

**ABSTRACT:** This paper summarizes Media-converter is a networking device that makes it possible to connect two dissimilar media types such as copper to fiber optic cable with OAM feature (Operation Administration and Maintenance).Media Converters are used in MAN access network (metropolitan area network) and data transport services to enterprise customers and Fiber to the Home (FTTH) for broadband access for last-mile solution, mainly for end users. The OAM media converter is implemented using the chipsets of PIC and Broadcom, explained in detail. The main benefit of the proposed OAM feature is its simplicity, compact and low cost design. Finally, a media converter with an OAM feature was built and is currently in the process of testing.

**KEYWORDS:** Operation Administration and Management (OAM); Field Programmable Gate Array (FPGA); Ethernet

## I. INTRODUCTION

A **media converter** is a simple and inexpensive networking solution device that makes it possible to connect two dissimilar media types like conversion of copper media to fiber media. and fiber to copper media. They are important in converting copper port to an Optical port with an SC connector. The use of fiber optics is advisable when reliability demands are high or there are long distances to cover. They are also used in metropolitan area network (MAN) access and data transport services to enterprise customers. Media converter types range from small standalone devices high and PC card converters to port-density chassis systems that offer many networking features like fiber link status and copper link status. On some devices, Simple Network Management (SNMP) enables proactive management of copper and fiber link statistics and sending traps to network managers in the event of a copper or fiber break status, monitoring chassis environmental .Here the terminal machine is connected to central machine via optical fiber. The management information of the terminal machine is observed in the central machine.OAM describes optical interface and logical functions of a media converter applied for a fiber media, that has operations, administration and maintenance functionsOAM frame will have the following features which is explained in the section Conclusion and results:Fiber Path Testing Copper Path TestingPropriety info (if any)OAM is the protocol for installing, monitoring and troubleshooting Ethernet metropolitan area network (MANs) and Ethernet WANs.

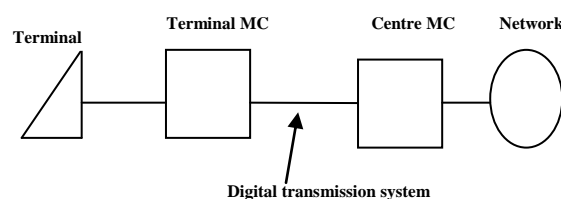

Figure 1 Optical interface reference configuration of media converters

# International Journal of Innovative Research in Science, Engineering and Technology

(An ISO 3297: 2007 Certified Organization)

Vol. 4, Issue 5, May 2015

## II. SYSTEM ARCHITECTURE

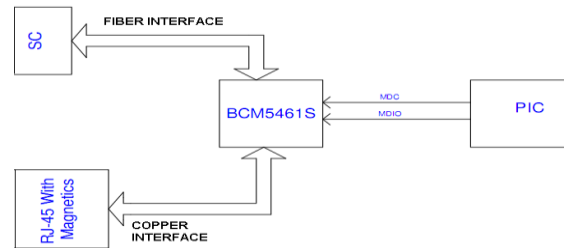

Figure 2: System Architecture

The board works as an unmanaged media converter which supports 1000 Mbps speed and identifies OAM events like copper link and fiber link. The main chipsets used are 10/100/1000 Ethernet Transceiver and PIC Microcontroller.

### A) HARDWARE INTERFACES

#### B) Copper Interface

RJ-45 with Magnetics and without LED has been used for copper interface and connected to BCM5461S. The power supply used for Magnetics Center tap is +2.5V.

#### C) Fiber Interface

The optical transceiver used is Hi-Optel's This is a high performance, cost effective module, which is compliant with Gigabit Ethernet and Standard of IEEE-802.3. This transceiver operates at the normal wavelength of 1310 nm.

#### D) BCM5461S

Gigabit Media converter which converts Electrical signals to optical signals. This is generally a Gigabit PHY, which converts electrical signal to Optical Signal. This PHY management interface has been operated from PIC for initialization and as well as PIC gets Link related information to display FEF failures

#### E) PIC24JF64GA

PIC is a controller, which has been communicating with BCM5461S through 2-wire management interface for PHY initialization and to get Link failure details. PIC gets an interrupt from BCM5461S, in case of link failure and PIC has to read BCM5461S registers to analyze and display the type of failure. PIC controls Copper OK, Copper FEF, Fiber OK, and Fiber FEF LEDs depending upon status of registers read from BCM5461S.

Along with the above interface it also indicates the faulty condition on the LEDs. Below is the description.

Power on LED: To indicate power module ON

Activity LED: To indicate the activity between Fiber and copper port.

Copper OK LED: To indicate Copper Link and cable are ok.

Copper FEF LED: To indicate Copper Link is down and it is because of Remote Copper is down.

Fiber OK LED: To indicate Fiber Link and cable are ok

Fiber FEF LED: To indicate Fiber link is down and its because of Fiber TX cable cut.

## III. METHODOLOGY

### 3.1 BLOCK DIAGRAM

The basic building of a design is a block diagram which is shown figure 2. It describes one gigabit copper port and one fiber port interfaced to gigabit PHY with the PIC interface for initialization

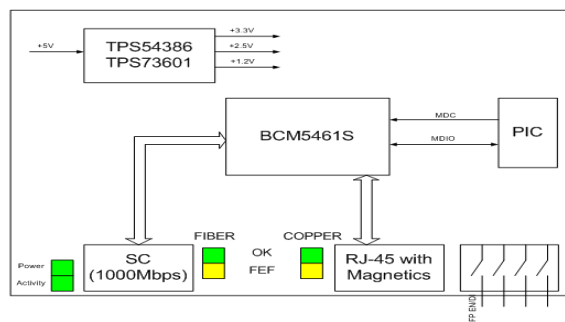

Figure 3: Proposed Work Block diagram

### A) Power Analysis

TPS54386 is used for the generation of the 3.3V and 1.2 V from 5 V.

TPS73601 is used for the generation of 2.5V from 3.3V

The power budgeting is calculated for 1.85 Watts

The functionality of the main chipsets is mentioned below.

### B )Schematics and CAD :

Mentor Graphics Design Capture and PCB CAD Tool is used for schematic entry and routing.

The major challenging work is to place all the components and discretives on the PCB size which is 90 x 54 mm. The placement of the components as shown in the figure 4 component placement

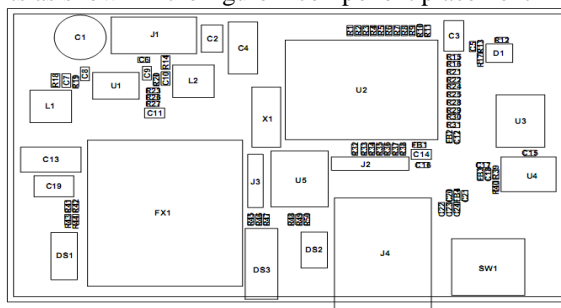

Figure 3.1 component placement

The PCB routing is completed in 4 layers and physical picture of the implemented hardware is shown in figure 5.



Figure 3.2 : Developed Hardware

### IV. CONCLUSION AND RESULT

A Hardware platform is designed to prove the functionality of OAM based Media converter architecture. The OAM Features was implemented in a PIC base controller and design is based on a Broadcom chipset. A system

## International Journal of Innovative Research in Science, Engineering and Technology

(An ISO 3297: 2007 Certified Organization)

Vol. 4, Issue 5, May 2015

level experimental set up was developed to validate the OAM features of Media converter to verify the UTP and Fiber failure for the local and remote device and functional status monitoring is implemented using led display.

Developed Hardware for the TEST SET UP :

The Block Diagram shows the system level set up using developed hardware as DUT-1 and DUT-2 connecting two device back to back for demonstrating the OAM features implemented for UTP and Fiber cut.

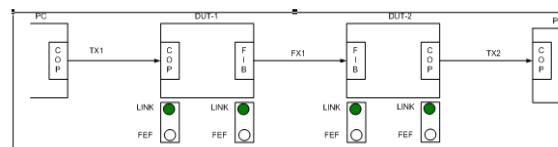

Figure 4 : Test set up no copper or fiber cut

The developed hardware set up is named as DUT-1 and DUT-2 and set up is made as shown in figure 6. Connect DUT1 Fiber TX to DUT2 fiber RX and vice versa. Now connect DUT1 Copper to PC1 and DUT2 copper to PC2. , Connect DUT1 Fiber TX to DUT2 fiber RX and vice versa. Now connect DUT1 Copper to PC1 and DUT2 copper to PC2. Now ping IP which is connected to PC1 from PC2 .If proper connectivity in copper and fiber is there there will not be any ping drop and no FEF indications on LEDs

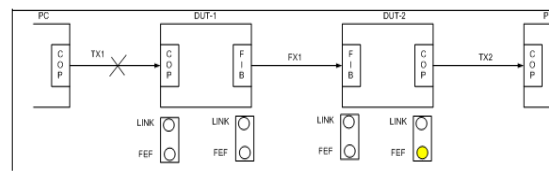

Figure 4.1 Test setup for copper cut for DUT-1 device

Cut the copper cable (TX1) connected to DUT-1 .Observation observed on LEDs Local copper link fail on DUT-1,as TX1 is local to DUT-1 device. No green color LED of copper is observed on DUT-1 device.FEF link indication for copper event is observed on DUT-2 ,which is indicated in yellow color on DUT-2 device

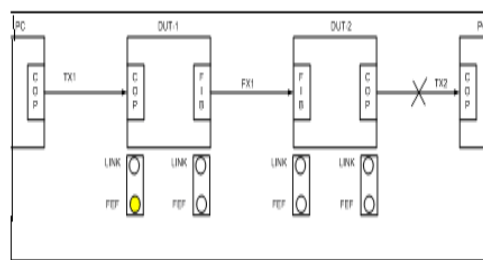

Figure 4.2 Test setup for copper cut for DUT-2 device

Cut the copper cable (TX2)connected to DUT-2 .Observation observed on LEDs.Local copper link fail on DUT-2. No green color LED of copper is observed on DUT-2 device.FEF link indication for copper event is observed on

## International Journal of Innovative Research in Science, Engineering and Technology

(An ISO 3297: 2007 Certified Organization)

Vol. 4, Issue 5, May 2015

DUT-1, which is indicated in yellow color on DUT1 device.

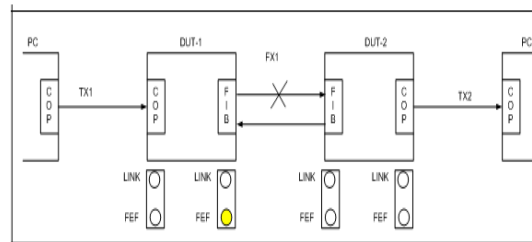

Figure 4.3 Test setup for fiber cut for DUT-2 device

Cut the transmit fiber cable (FX1) connected from DUT-1 to DUT-2. Observation observed on LEDs  
Local fiber link fail on DUT-2, No green color LED of fiber link is observed on DUT-2 device.  
FEF link indication for fiber event is observed on DUT-2, which is indicated in yellow color on DUT-1 device.

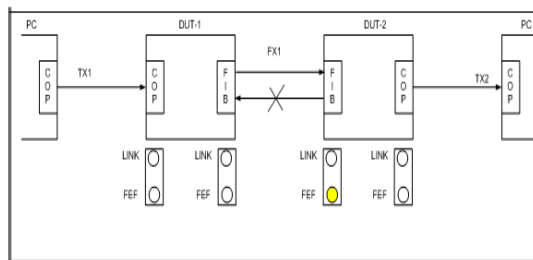

Figure 4.4 Test setup for fiber cut for DUT-1 device

Cut the transmit fiber cable (FX1) connected from DUT-2 to DUT-1  
Observation observed on LEDs  
Local fiber link fail on DUT-1, No green color LED of fiber link is observed on DUT-2 device.  
FEF link indication for fiber event is observed on DUT-2, which is indicated in yellow color on DUT-2 device.  
The below table describes about the LED functionality. Depending on the OAM event like Copper, fiber Cut the following LEDs will function accordingly.

## International Journal of Innovative Research in Science, Engineering and Technology

(An ISO 3297: 2007 Certified Organization)

Vol. 4, Issue 5, May 2015

SL NO	LED	OFF	ON	BLINK
1	PWR	Device not powered on	Device is powered on and the 3.3V is generated.	----
2	Activity LED	----	- ---	Indicate the activity between fiber and copper ports
3	Copper Link	Copper Link Down	Copper Link ok.	----
4	Copper FEF	No Copper FEF	Copper link is down because of Remote copper down.	----
5	Fiber Link	Fiber Link Down	Fiber Link ok.	----
6	Fiber FEF	No Fiber FEF	Fiber link is down because of TX cable cut at remote side.	-----

# International Journal of Innovative Research in Science, Engineering and Technology

(An ISO 3297: 2007 Certified Organization)

Vol. 4, Issue 5, May 2015

## V. CONCLUSION

In this paper, we propose a low tangling and awesome DCT change in light of the CORDIC computation is shown. The proposed CORDIC based Integer DCT building plan simply have need of 78 cuts rather than 120, number of LUT's are 110 rather than 156 and deferral has been diminished to .2ns so speed has been enhanced in ideal level. The proposed count not simply lessens the computational multifaceted design widely stood out from the first customary DCT; it in like manner keeps the considerable quality change result. In this look upon, the proposed DCT figuring is amazingly suitable for low zone and fast sign changing applications, for instance, HEVC.

## REFERENCES

- [1] Juraj Poliak, Michal Kubípek ,”FPGA-based Media Converter for FSO Links” , 2nd International Workshop on Optical Wireless Communications ,pp157-161,October 2013
- [2]Daniel Cárdenas, Antonino Nespola, Pietro Spalla, Silvio Abrate, and Roberto Gaudino, "A Media Converter Prototype for 10-Mb/s Ethernet Transmission Over 425 m of Large-Core Step-Index Polymer Optical Fiber," Light wave Technology, Vol. 24, Issue 12, pp. 4946-4952 ,2006
- [3]Jeong-dong Ryoo, ETRI,Hao Long and Yang Yang, Huawei Technologies,Marc Holness, Nortel Networks,Zahir Ahmad and J. Kevin Rhee, Information and Communications University,” Ethernet Ring Protection for Carrier Ethernet Networks”, IEEE Communications Magazine,pp137-143,2008
- [4]Delrosso.G Pirelli Labs. spa, Milan,Maggi,L,” Development of gigabit Ethernet fiber optic media converter module to meet European FTTH standard”, Electronics System-Integration Technology Conference, pp 623-628,2008.
- [5]Koonen, T ,COBRA Inst., Eindhoven Univ. of Technol.” Fiber to the Home/Fiber to the Premises: What, Where, and When? “,Proceedings of the IEEE ,(Volume:94 , Issue: 5,pp 911-934,2006
- [6]Salah A. Jaro Alabady,” Performance Analysis of an Optical Gigabit Ethernet”,Computer Engineering Department University of Mosul,Iraq,Volume 16,pp 28-37,2009
- [7]Yukihiro FUJIMOTO,” Application of Ethernet Technologies to FTTH Access Systems ” , IEICE TRANS. COMMUN., VOL.E89-B, NO.3 pp 661-667 , 2006
- [8]Jaedon Kim,Marvell Semicond. Inc., Sunnyvale,Maier, M. ; Hamada, T. ; Kazovsky, Leonid G,” OBT: Optical Burst Transport in Metro Area Networks “,Communications Magazine, IEEE ,Volume:45,pp 44-51,2007