

Design and Study on Behaviour of Skew Slab Bridges with Various Skew Angles

Raj KK¹ and Phani RG²

¹Department of Structural Engineering, Velagapudi Ramakrishna Siddhartha Engineering College, Jawaharlal Nehru Technological University -Kakinada, Andhra Pradesh

²Civil Engineering department, Velagapudi Ramakrishna Siddhartha Engineering College, Jawaharlal Nehru Technological University –Kakinada, Andhra Pradesh

Research Article

Received date: 14/09/2017
Accepted date: 26/09/2017
Published date: 18/09/2017

*For Correspondence

Frederic BM, Faculty of Science, University of Yaounde I, P.O. Box 812 Yaounde, Cameroon, France

E-mail: kolaventirajkumar@gmail.com

Keywords: Skew angle, STAAD PRO, Skew Slab

ABSTRACT

In this modern Era, Many highway bridges are skewed and their behavior and corresponding design analysis need to be furthered to fully accomplish design objectives. This project deals with the behavior of simply supported skew slab bridges with various skew angles 00,150,300,450& 600. A detailed study on variation of bending moments in simply supported skew slab bridges with various skew angles is given in this project using structural analysis software STAAD PRO, and analysis is as per provisions of Indian codes IRC 6 : 2014

INTRODUCTION

Bridge slabs by their nature have their supports only on two edges and the two remaining edges are free. They carry traffic at the top and cross an obstruction. The brackets for such plates are sometimes not orthogonal for the direction of traffic that is necessary for many reasons. These bridge decks are defined as oblique bridge decks. From the analytical point of view, knowledge about design and behaviour is limited and from the practical point of view, detail is very involved and visibility is restricted. There are several practices to reduce biased effects, as there are many apprehensions (anxieties) about correct behaviour prediction and proper designs of biased bridges especially if the angle of inclination is very high. In some cases, bias effects are avoided by appropriate choice of media orientation. The foundations and substructures could be oriented in the direction of the flow of the river track or railway at a biased junction. But the easel cap could be provided in such a way so that the cover system forms a right cover (not a bias cover). This could also be achieved in a simple manner by choosing the single circular column spring [1, 2].

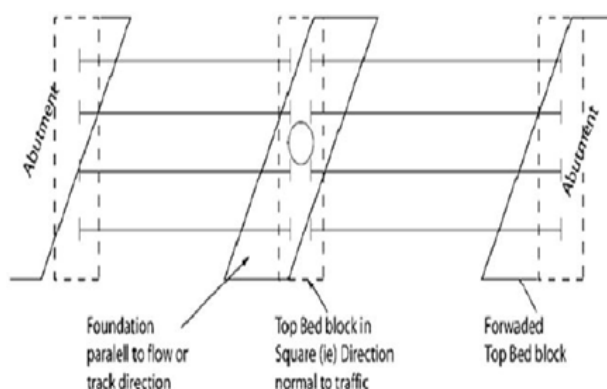

Figure 1.1. Skew spans converted as right span girders by placement of bed block on top of pier.

Behavior of Skew Bridge Decks

Normally, a rectangular slab bridge deck behaves in flexion orthogonally in the longitudinal direction and transverse. The main moments are also in the direction of traffic. The direction and the principal moment can be recognized by the deformation pattern [3,4].

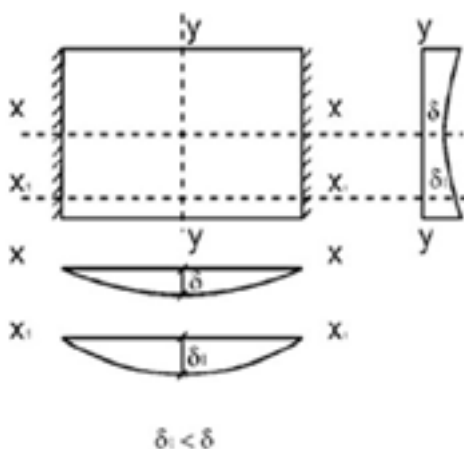

Figure 1.2. Deflection profiles in a right deck.

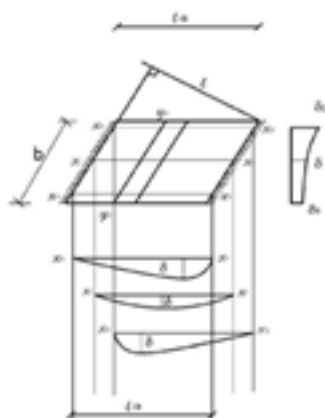

Figure 1.3. Deflection profile in a skew deck slab.

The slab bends longitudinally leading to a moment of sagging. Therefore, the deflection of the medial longitudinal strip will be less than the deformation of the longitudinal medial strip. The median longitudinal band along xx is supported by a strip adjoining each side. The longitudinal strip near the free edges said length 1×1 is supported by a contiguous strip on only one side, the other side being a free edge. The deflection of the slab is also not uniform and symmetrical as in a right cover. There will be warp which will lead to greater deflection near areas of angled obtuse angle and less deviation near angular areas of acute angle [5,6]. Figures show the deformation pattern of a right slab cover and also the skid slab cover for sloped slabs the force flow is through the area strip connecting the angled obtuse corners and the slab is mainly folded along the line joining obtuse angled curves. The width of the primary bending strip is a function of the tilt angle and the ratio of the tilt amplitude to the width of the tire (aspect ratio). Areas on both sides of the strip do not transfer the load to the brackets directly but only transfer the load to the strip as cantilever. Therefore, the biased slab is subjected to torsional moments. This torque is not small and therefore cannot be neglected. Because of this, the direction of the principal moment also varies and is the function of a skewed slab.

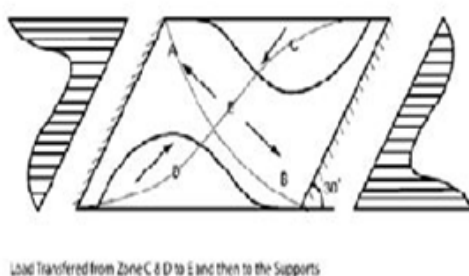

Figure 1.4(a). Force flow in a skew deck.

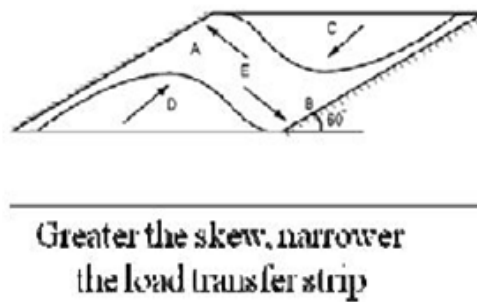

Figure 1.4(b). Force flow pattern in skew deck slab.

The transfer of the load from the strip to the support line is along a defined length along the support line from obtuse angular curves. Then the force is redistributed for the full length.

The flow of force is shown in Figure 1.4 (a and b). The fine lines of Figure 4(a) indicate the shape of the deformation. The distribution of the reaction forces along the length of the supports is also shown on both support sides.

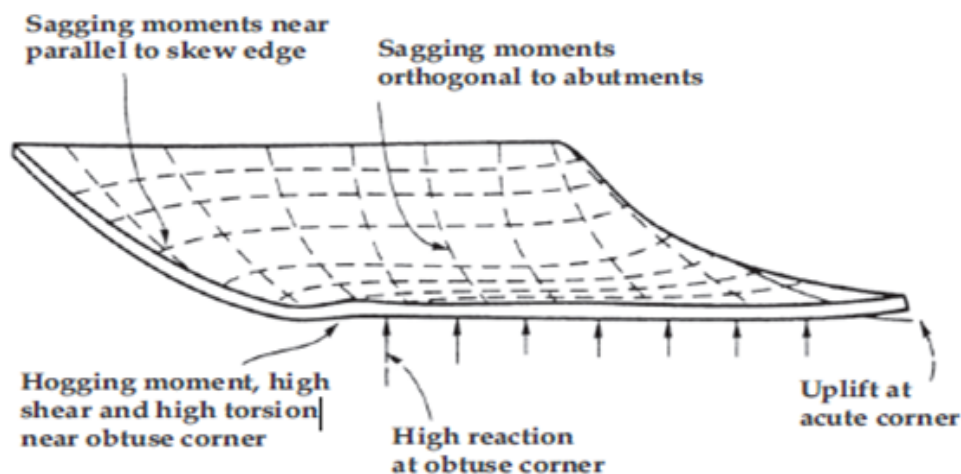

Figure 1.5. Behaviour of skew bridge deck.

Significant Features of Skew Deck Regarding Right Deck the characteristic differences in the behaviour of the skid deck with respect to the right deck are

High reaction in obtuse corners [7].

Possibility of elevation in acute angles, especially in the case of the slab with very high inclination angles.

Negative moment along the support line, high shear and high torque near obtuse corners.

Moments of flaccidity orthogonal to the pillars in the central region.

At the free edges, maximum moment closer to the obtuse corners than in the centre. Skew. The points of maximum deflection closer to angles of obtuse angle (This change of point of maximum deviation towards obtuse corners is more if the angle of inclination is more).

The maximum longitudinal moment and also the deformation are reduced with the increase of the inclination Angle for a given aspect ratio of the slanted slab

As the inclination increases; more reaction is produced towards obtuse angular corners and less in the sharp angled corner. Therefore, the distribution of the reaction forces is not uniform on the support line.

MODELLING

Modelling of the Slab Bridge in Staad Pro.V8i

After the preparation of the preliminary model in STAADpro.v8i. Make a node using the node cursor on the cursor bar at the left edge of the screen and select the "Repeat Translation" option on the toolbar. A dialog box will appear as shown below.

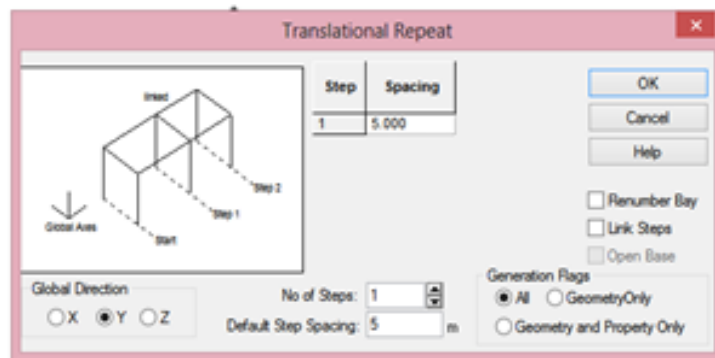

Figure 2.1. Dialog box showing Translational Repeat in STAAD Pro.v8i.

Select Global Address as Y Enter the number of steps as 20 and step spacing as 1 m. Press “OK”.

Now 20 nodes with 1 m spacing will appear on the screen. Now, by clicking on the node cursor, select all 20 nodes. Again, click on the "Repeat translation" option. Now select the Global address as X Input steps as 10 & spaced step as 1 m. Press OK. "Now a 20 * 10 noded rectangular slab set will appear as below.

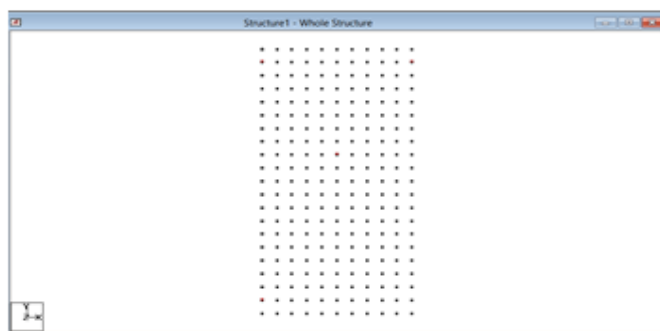

Figure 2.2. Generation of mesh in STAAD Pro.v8i.

Now select the "Generate Surface Mapping" option in the toolbar. And generate the surface by connecting every 4 nodes. This completes all the surface meshing.

Generate and place connecting beams on all joints of the panel by horizontal and vertical beams of very small dimensions that help in loading load surface as pressure on the entire plate.

Now our required 20 m × 10 m iron is ready.

Now assign the member property, thickness, material property, support conditions to the slab model.

Now go to the loads and definitions section, create several load cases that we need. Add and assign them to the slab model.

Now click on the "Run Analysis" option and perform analysis.

After completing "Run Analysis", it will display the number of errors and warnings.

If the number of errors and warnings is reasonable (acceptable), select option "go to the post processing mode".

Full slab bridge model with slope angle of 00 (no inclination) with all details like material, supports, feature, thickness and various load cases are as below.

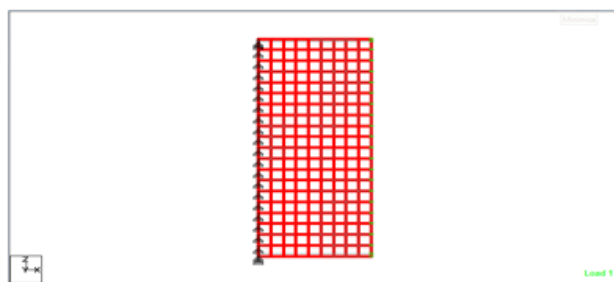

Figure 2.3. Modelling of skew slab of 00 (no skew) with Self Weight.

Modelling of the Skew Slab Bridge in Staad Pro.V8i

Now we have to prepare an Excel sheet for biased lengths for several angles of inclination. Using this Excel sheet, we can generate slab models with various tilt angles of 150, 300, 450 and 600.

By using this Excel sheet, we can generate slab models with various tilt angles of 150, 300, 450 and 600 as shown below.

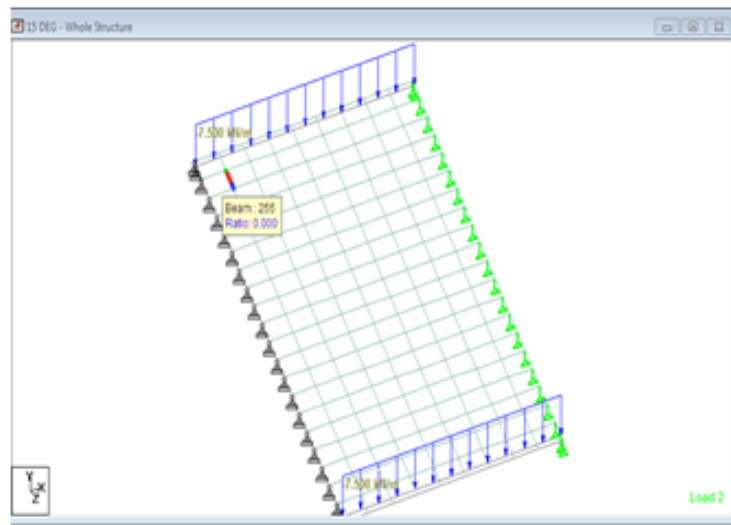

Figure 2.4(a). Modelling of 150 skew slab with SIDL.

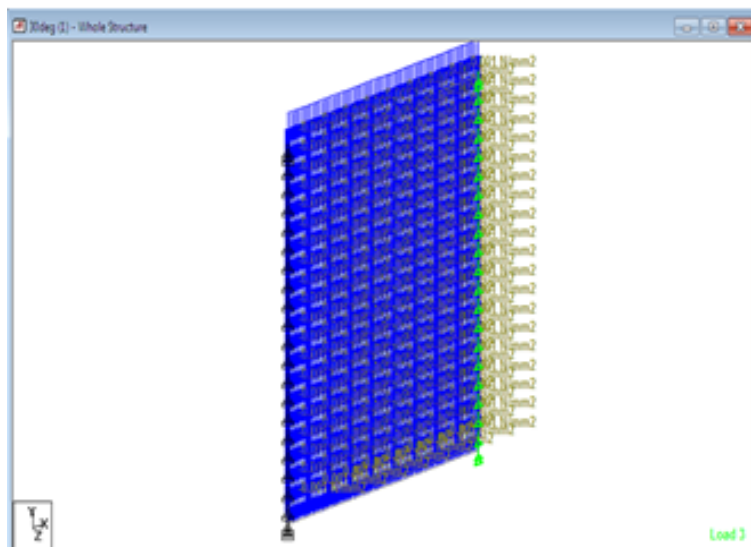

Figure 2.4(b). Modelling of 300 skew slab with WC.

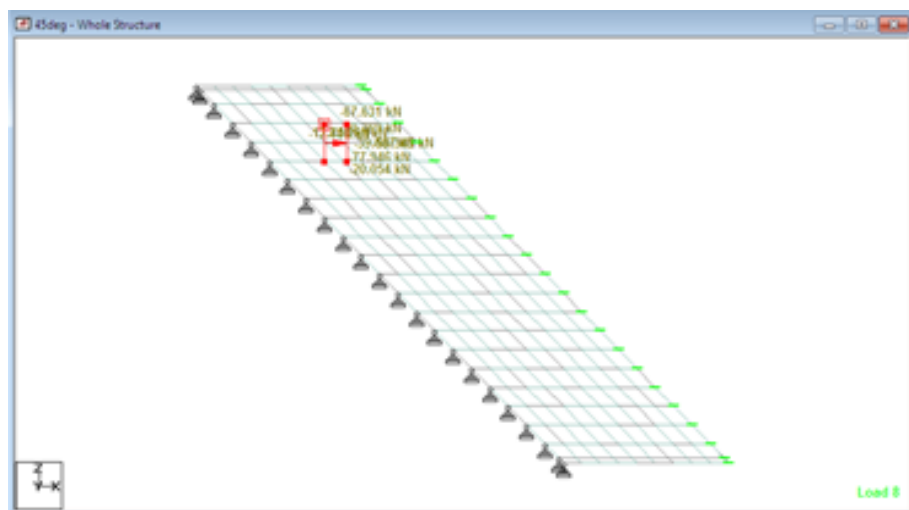

Figure 2.4(c). Modelling of 450 skew slab with 70R Bogie load.

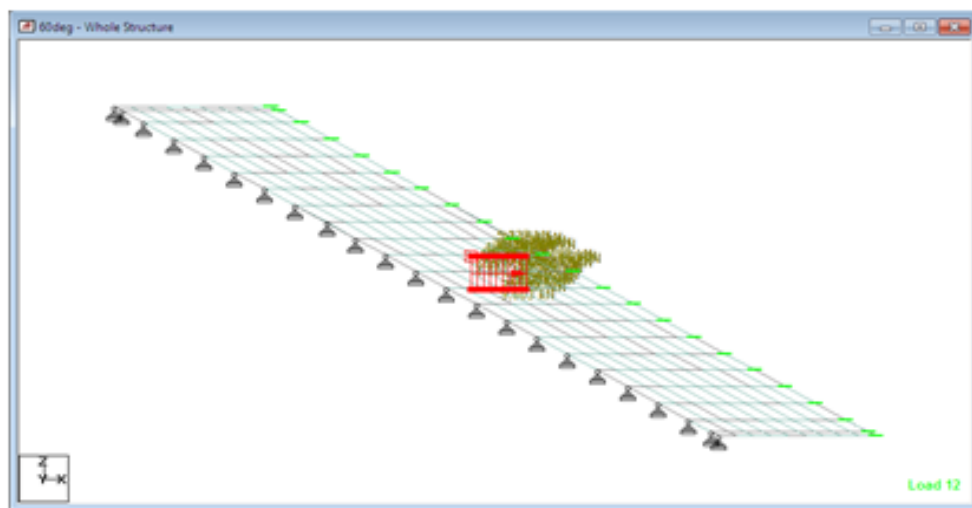
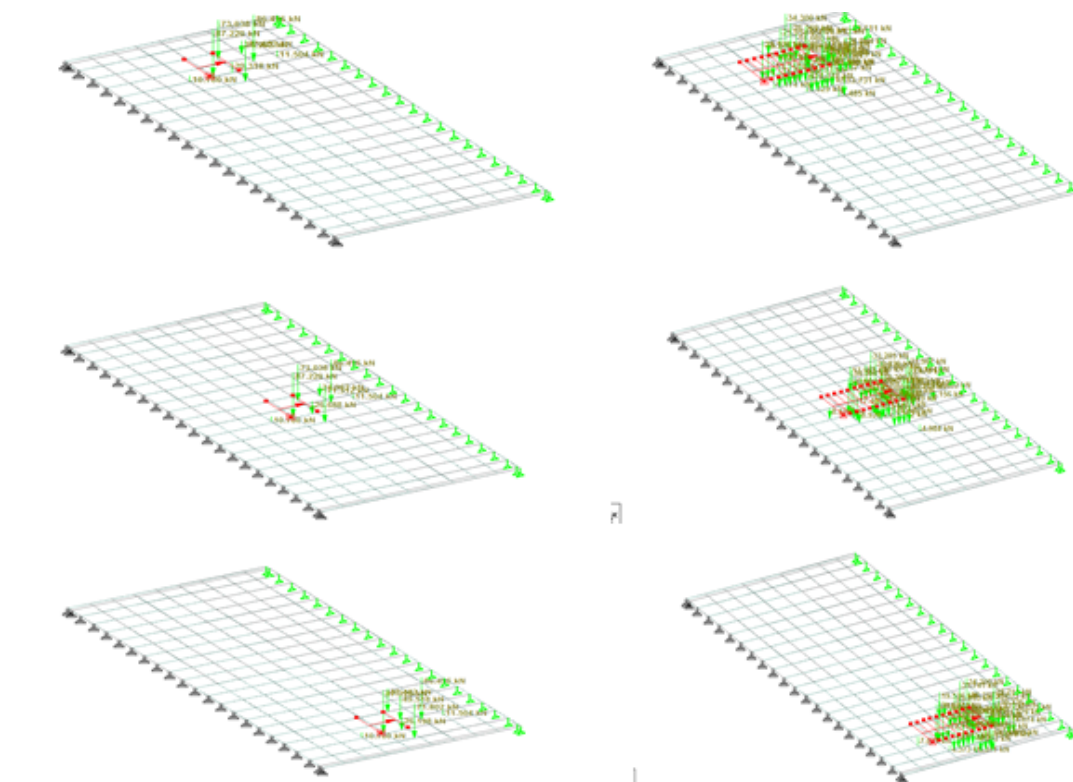

Figure 2.4(d). Modelling of 60 skew slab with 70R Tracked load.

Positioning of Vehicles on the Skew Slab Bridge in Staad Pro.V8i



Various positions of Class 70R Bhogi vehicle various positions of class 70R tracked vehicle.

DESIGN OS SKEW SLAB

Table 1. Design Os skew slab.

Design Os Skew Slab				
Skew	15	30	45	60
Grade of concrete	25	25	25	25
f_{st}	240	240	240	240
Grade of steel	500	500	500	500
f_{cbc}	8.33	8.33	8.33	8.33
Overall depth	700	700	700	700
Cover	40	40	40	40
Eff cover	52.5	52.5	52.5	52.5
Eff depth	647.5	647.5	647.5	647.5

m	10	10	10	10
j	0.914	0.914	0.914	0.914
k	0.258	0.258	0.258	0.258
Q	0.981	0.981	0.981	0.981
Longitudinal Moment				
HOG(kN-m/m)	24.22	53	65.65	31.6
Dreq	157.1276	232.436	258.6919	179.4771
Ast Required (mm ² /m)	170.5206	373.1459	462.2081	222.4794
Dia of bar	16	16	16	16
spacing	200	200	200	200
Ast provide (mm ² /m)	1005.31	1005.31	1005.31	1005.31
SAG(kN-m/m)	94.64	86.7	55.8	31.39
Dreq	310.601	297.2864	238.4968	178.8797
Ast Required (mm ² /m)	666.3118	610.4103	392.8593	221.0009
Dia of bar	16	16	16	16
spacing	200	200	200	200
Ast provide (mm ² /m)	1005.31	1005.31	1005.31	1005.31
Transverse Moment				
SAG(kN-m/m)	396	330.5	235	134.5
Dreq	635.3501	580.4318	489.44	370.2769
Ast Required (mm ² /m)	2788.033	2326.881	1654.515	946.9457
Dia of bar	25	25	25	25
spacing	150	150	150	150
Ast provide (mm ² /m)	3272.492	3272.492	3272.492	3272.492

RESULTS

Moments of the Skew Slab Bridge in Staad Pro.V8i

The following are the bending moment values of various skew slabs with various load cases at different positions.

Moments are taken in both X & Y directions.

Moment in X direction is MX; Moment in Y direction is MY

Moment in X direction is (MX) is in Transverse direction. Moment in Y direction is (MY) is in Longitudinal direction. MX - Transverse Moment; MY - Longitudinal Moment

In MX, We get both sagging & hogging moments. But, in MY we get only sagging moments.

The Moment values (both MX & MY) are shown in **(Tables 1 and 2)**

Table 1. MY Values.

Skew angle	15	30	45	60
LL(kN-m)	190	160	117	70
DL(kN-m)	157	132	92	50
SIDL(kN-m)	35	27	18	10
WC(kN-m)	14	11.5	8	4.5

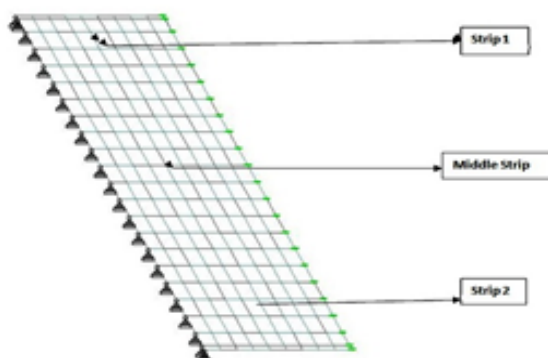

Figure 3.1. Representation of strips.

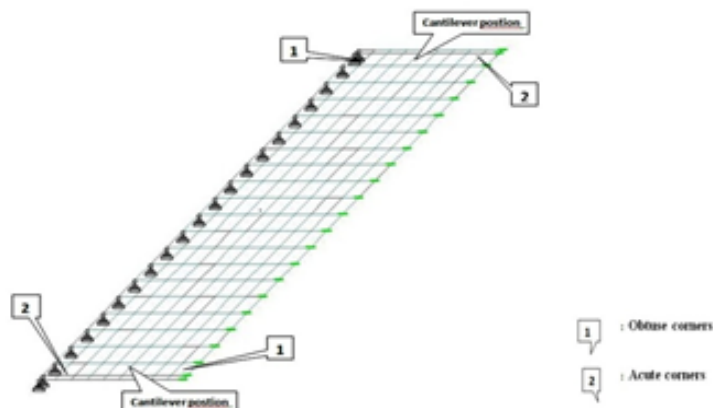

Figure 3.2. Representation of corners.

Table 2. M_x values.

NOSKEW CASE										
	STRIP-1		MIDDLE STRIP		STRIP-2		ACUTE		OBTUSE	
	SAG	HOG	SAG	HOG	SAG	HOG	SAG	HOG	SAG	HOG
D.L	1.9	0	27.8	0	1.9	0	6.4	0.4	6.4	0.4
SIDL	0	0.174	0	2.32	0	0.174	1.2	6.7	1.2	6.7
W.C	0.16	0	2.42	0	0.16	0	0.56	0	0.56	0
L.L	191.6	0	120	12	191.6	0	50.1	3	50.1	3
	193.66	0.174	150.22	14.32	193.66	0.174	58.26	10.1	58.26	10.1
15DEG SKEW CASE										
	STRIP-1		MIDDLE STRIP		STRIP-2		ACUTE		OBTUSE	
	SAG	HOG	SAG	HOG	SAG	HOG	SAG	HOG	SAG	HOG
D.L	5.1	4.4	25.8	0	5.1	4.4	8.11	0	0	10.22
SIDL	0	0.42	0	2.1	0	0.42	0.827	4.31	0	2.6
W.C	0.44	0.38	2.24	0	0.44	0.38	0.7	0	0.9	0
L.L	2.25	1.85	66.6	12.55	15.6	3	10.64	2.7	11.4	11.4
	7.79	7.05	94.64	14.65	21.14	8.2	20.277	7.01	12.3	24.22
30DEG SKEW CASE										
	STRIP-1		MIDDLE STRIP		STRIP-2		ACUTE		OBTUSE	
	SAG	HOG	SAG	HOG	SAG	HOG	SAG	HOG	SAG	HOG
D.L	8.1	10.6	20.7	9.6	8.1	10.6	7.32	0	0	24
SIDL	0	1.3	0	2.5	0	1.3	0	5.3	1.2	1.9
W.C	0.7	1	1.8	0.83	0.7	0.91	0.63	0	0	2.1
L.L	3.5	3.7	64.2	11.4	18.7	3	7.75	3.5	6.7	25
	12.3	16.6	86.7	24.33	27.5	15.81	15.7	8.8	7.9	53
45DEG SKEW CASE										
	STRIP-1		MIDDLE STRIP		STRIP-2		ACUTE		OBTUSE	
	SAG	HOG	SAG	HOG	SAG	HOG	SAG	HOG	SAG	HOG
D.L	10.7	12.9	14.1	16.8	10.7	12.9	6.85	0	0	38.5
SIDL	0	2.33	0	2.4	0	2.4	0	7.56	1.75	3
W.C	0.9	1.1	1.2	1.5	0.92	1.11	0.6	0	0	3.35
L.L	3	3.8	40.5	6.7	20	0.54	0.8	3.3	5	20.8
	14.6	20.13	55.8	27.4	31.62	16.95	8.25	10.86	6.75	65.65
60DEG SKEW CASE										
	STRIP-1		MIDDLE STRIP		STRIP-2		ACUTE		OBTUSE	
	SAG	HOG	SAG	HOG	SAG	HOG	SAG	HOG	SAG	HOG
D.L	8.8	11.7	7.35	2.35	8.8	11.7	4.7	0	2.2	26
SIDL	0	2.8	0.29	0.87	0	2.8	0.48	8.2	1.1	2.3
W.C	0.77	1.1	0.64	0.21	0.77	1.1	0.4	0	0.19	2.2
L.L	8.23	4.1	23.11	4.83	16.1	3.37	0	2	3	1.1
	17.8	19.7	31.29	8.26	25.67	18.97	5.58	10.2	6.49	31.6

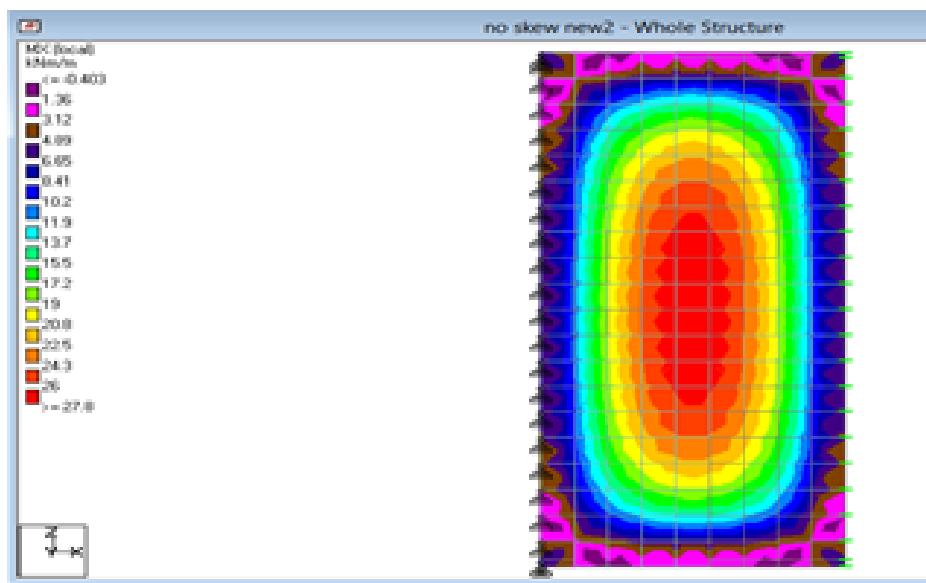
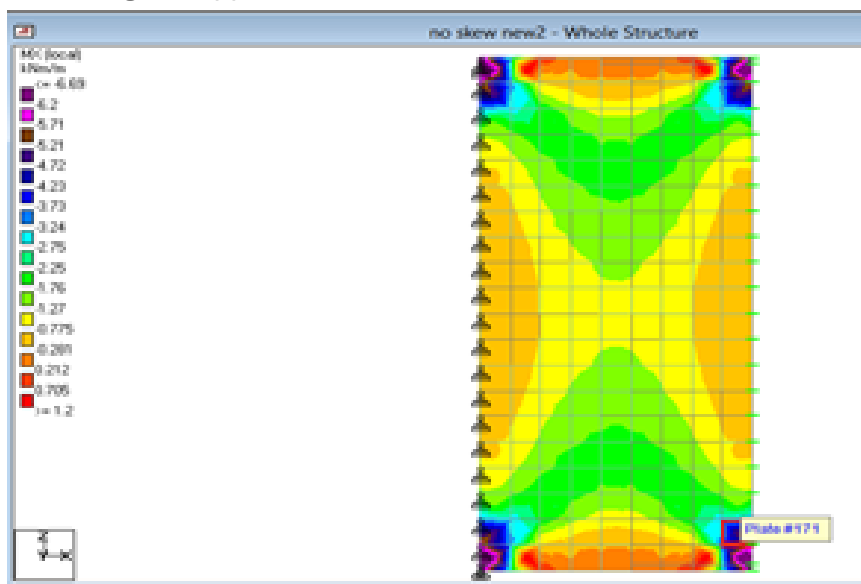
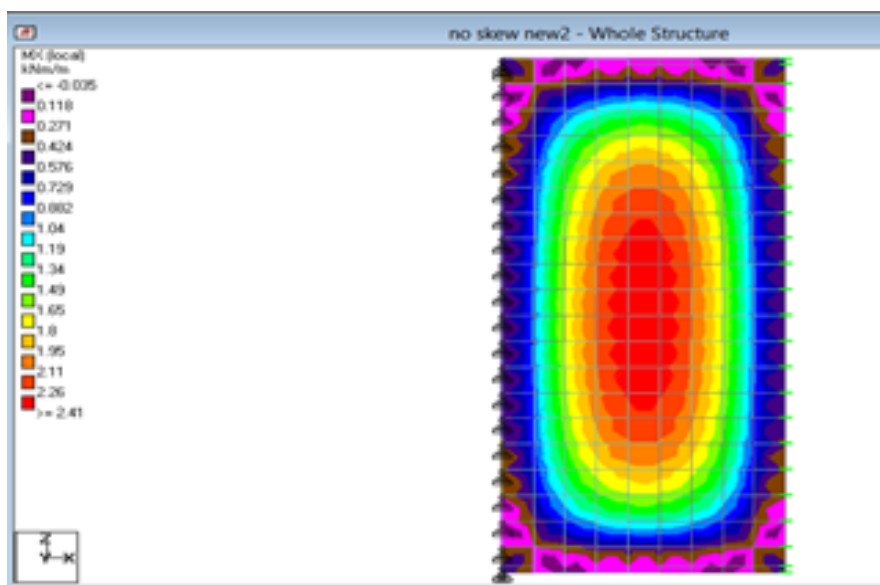

Figure 3.3(a). The Plate stress contours due to DL in no skew slab.



(b)The Plate stress contours due to SIDL in no skew slab.



(c)The Plate stress contours due to WC in no skew slab.

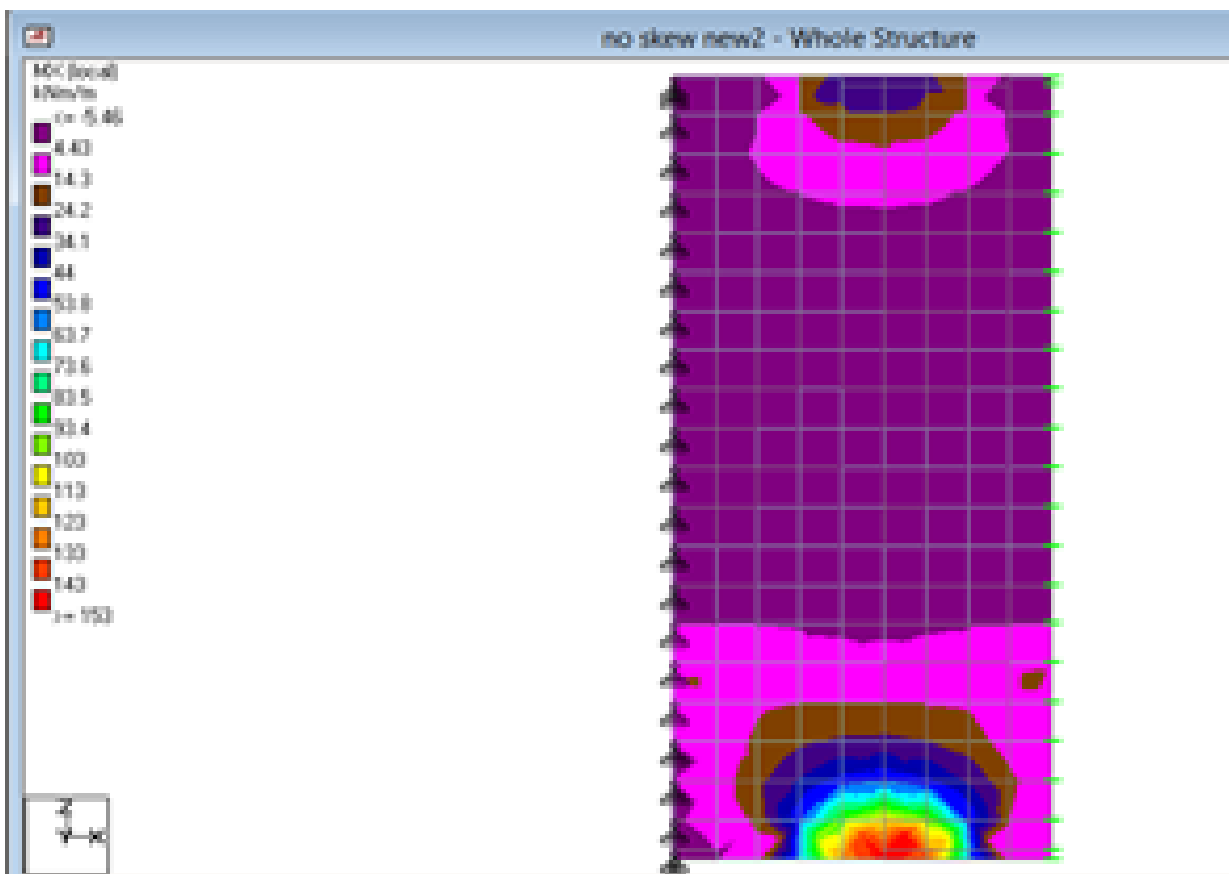

(d) The Plate stress contours due to Various LL case in no skew slab.

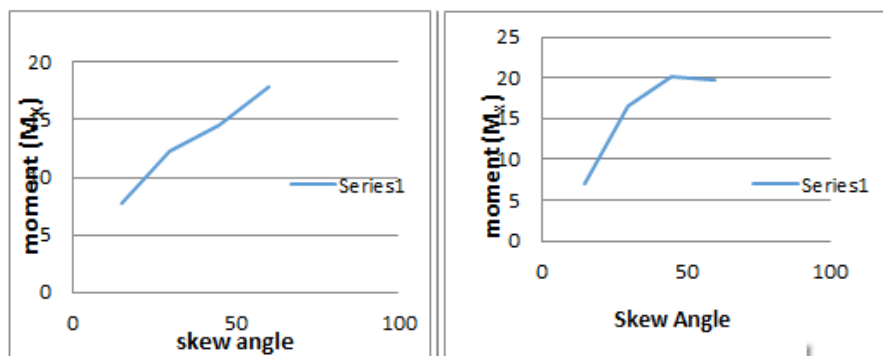

Sag in Strip 1. Hog in Strip 1.

Variation of moment (M_x) in Strip 1.

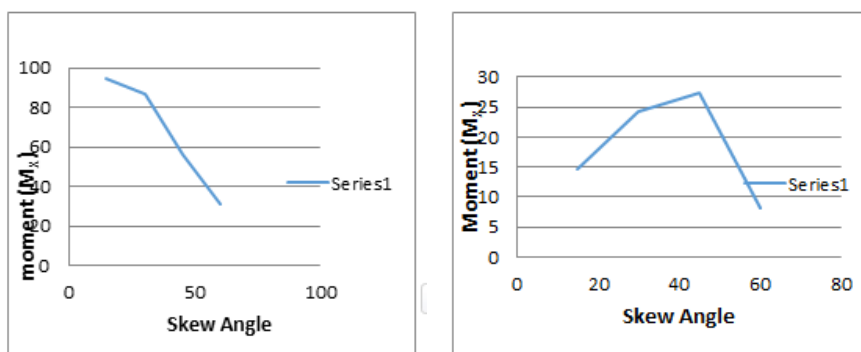

Sag in middle strip.

Hog in middle strip.

Variation of moment (M_x) in Middle Strip

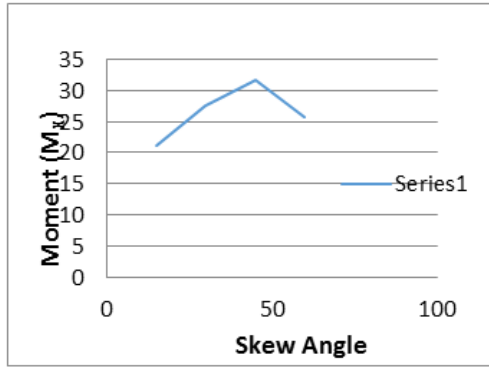

Sag in Strip 2



Hog in Strip 2

Variation of moment (M_x) in Strip 2

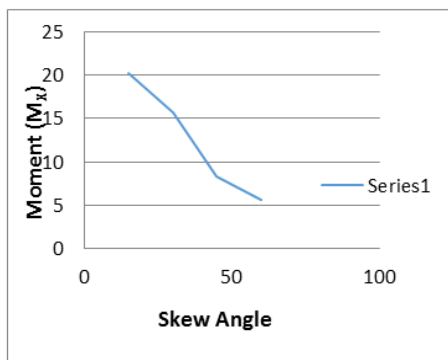

Sag in Acute corner

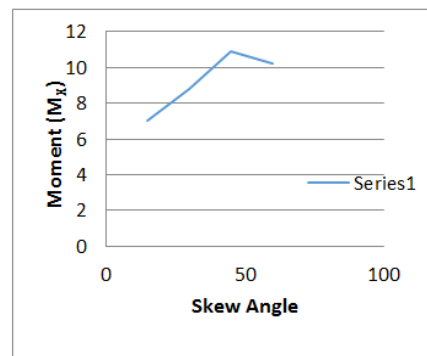

Hog in Acute corner

Variation of moment (M_x) in acute angle corner

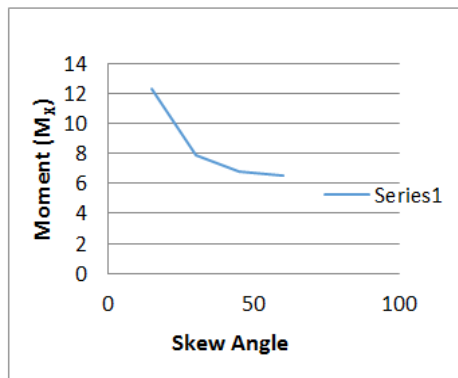

Variation of moment (M_x) in Obtuse angle corner

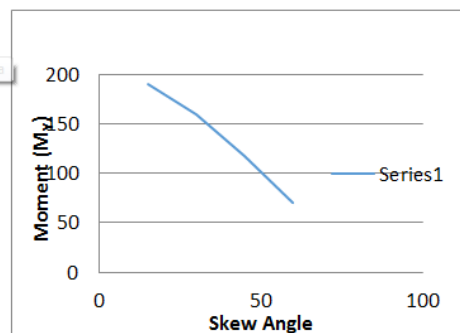
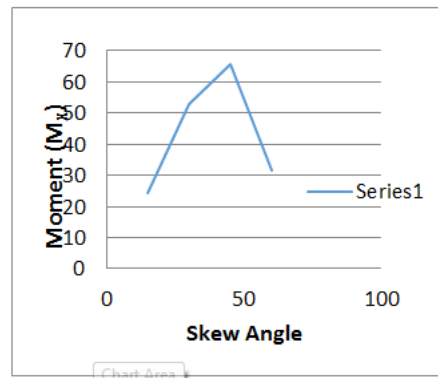

Variation of Moment (M_y) due to LL.

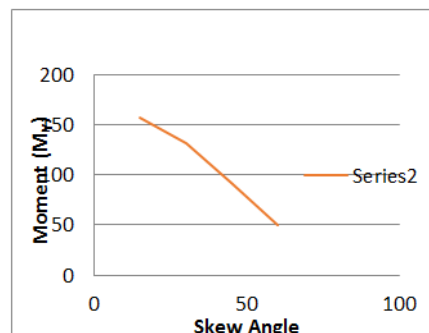

Variation of Moment (M_y) due to DL.

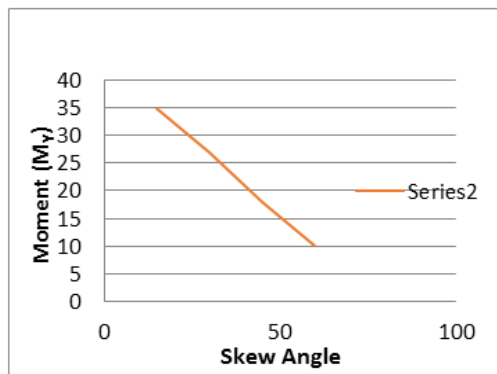

Variation of Moment (M_Y) due to SIDL.

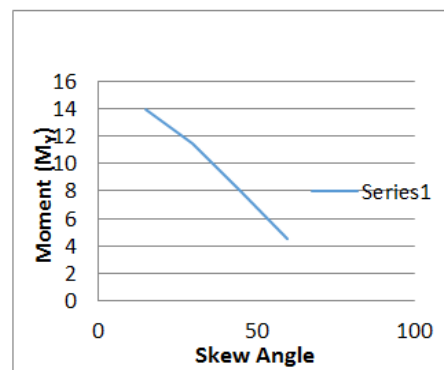

Variation of Moment (M_Y) due to WC.

Observations

1. For a smaller ratio of the amplitude to the width, the inclination has a marginal effect at the moment of design. With the increase of this ratio, the effect of the inclination increases.
2. For a lower tilt angle of up to 15 degrees, the tilt effect is minimal, while with the tilt angle increase the tilt effect is compounded.
3. For a smaller tilt angle of up to 15 degrees, the M_x value is small, while with the increase of the tilt angle the value M_x increases exponentially.

CONCLUSIONS

These conclusions are given on the basis of previous experimental results with the increase of the angle of inclination; the tensions in the slab differ significantly from those of a straight slab. A load applied on the slab moves to the support in proportion to the rigidity of the various possible paths. As a result, the maximum stress planes are not parallel to the centre line of the road and the slab tends to deform. The reactions at the obtuse inclined end of the slab support are larger than the other end, the increase in value over the mean value ranging from 0 to 50% for the inclination angle of 200 to 50°.

The reaction is negative for the angle of inclination greater than 50°. The reaction at the corner of the obtuse angle becomes twice the average reaction, thus making the acute angular corner a pressure zero point when the angle of inclination reaches approximately 60°. The reaction increased with increasing tilt angle. It increased about 80%, when it reached 60° compared to the right bridge. As the tilt angle increases, there is more chance of corner elevation. Moment of flexing decreases with increasing tilt angle decreased about 75% compared to the right jumper. The transverse moment increases as the angle of inclination increases, but to a certain angle after which it begins to decrease. Again increases as the tilt angle increases to 30°, but decreases to 20% and 40%, at 45° and 60° respectively. The torsion moment follows the same pattern as the transverse moment; Decreases after 45°. The maximum deflection occurs closer to the oblique angled corner, but as the angle of inclination is greater, it approaches more closely to the centre of the section and moves towards an oblique angled corner as the angle of inclination increases.

In this study, the behaviour of concrete reinforced concrete slab with different angles of inclination under static load has been investigated. The following conclusions are drawn from research.

- A. The general behaviour of the finite element models represented by the load-deflection curves show a good agreement with the experimental data. It is verified that the finite element analysis can accurately predict the load deformation similar to the experiment.
- B. The maximum deviation of the inclined slabs decreases with the increase of the inclination angle.
- C. The load capacity of the tilting slab increases as the tilting angle increases.
- D. Up to the angle of inclination 15° the behaviour of the slanted slab is almost similar to the rectangular slab.

REFERENCES

1. Ameerutheen M, Aravindan. Study of Stresses on Composite Girder Bridge Over Square and Skew Span Inter J Civ Engi Tech. 2014; 5: 88-96.
2. Anshuman K, Singh PK et al. Study on Effect of Skew Angle in Skew Bridges. Int J Eng Res Develop. 2012; 2: 13-18.
3. Rajagopalan N. Bridge Superstructure. Narosa Publishing House. Dhar, Arindam, Effect of skew angle on the behaviour of an IRC skew bridge. B.Tech Dissertation. Department of Civil Engineering, National Institute of Technology, Durgapur, 2012.

Research & Reviews: Journal of Applied Science and Innovations

4. Mehrdad B, Moving Load Analysis on Skewed Railway Bridge. J Asian Sci Res. 2013; 3: 198-203.
5. Anshuman K, Khatri V, Maithi PR, Singh PK. Study on the effect of skew angle in skew bridges" Int J Environ Res. 2012; 2: 13-18.
6. Qaqish, M. S. Effect of Skew Angle on Distribution of Bending Moments in Bridge Slabs. J App Sci. 2006; 6:366-372.
7. Indian Road Congress, New Delhi IRC 6-2014, "Standard Specification and Code of Practice for Road Bridges", Section II "Loads and Stresses", Indian Road Congress, New Delhi.