

# Power Generation from Staircase (Steps)

Ramesh Raja R<sup>1</sup>, Sherin Mathew<sup>2</sup>UG Scholars, Department of Mechanical Engineering, RVS College of Engineering & Technology Dindigul, India<sup>1,2</sup>

**Abstract—** We are using the non-renewable energy sources such as petroleum as well as renewable sources like solar, wind, tidal power etc., but still we couldn't overcome our power needs. So we have to generate electricity through each and every possible ways. Power can be generated through we are stepping on the stairs; the generated power will be stored and can be used for domestic purposes. This system can be installed at homes, colleges, railway stations, where the people move around the clock. The utilization of waste energy of human foot power is very much relevant and important for populated countries like India and China. A special mechanical arrangement such as crankshaft mechanism is employed on the stair case. This arrangement will convert the foot power applied on stairs, as a rotary motion. This rotary motion will be used to generate efficient electricity. It's an eco-friendly; easily accessible and non-conventional power generation system when compared to existing systems.

**Keywords—** foot step power, crowd power, renewable energy, human power to electricity, step power

## I. INTRODUCTION

This project attempts to show how energy can be tapped and used at a commonly used floor steps. The usage of steps in every building is increasing day by day, since even every small building has some floors. A large amount of energy is wasted when we are stepping on the floors by the dissipation of heat and friction, every time a man steps up using stairs. There is great possibility of tapping this energy and generating power by making every staircase as a power generation unit. The generated power can be stored by batteries, and it will be used for lighting the building.

## II. SCOPE OF THE PAPER

The utilization of energy is an indication of the growth of a nation. For example, the per capita energy consumption in USA is 9000 KWh (Kilo Watt hour) per year, whereas the consumption in India is 1200 KWh (Kilo Watt hour). We can say that to be materially rich and prosperous, a human being needs to consume more and more energy.

A recent survey on the energy consumption in India had published a pathetic report that 85,000 villages in India do not still have electricity. Supply of power in most part of the country is poor. Hence more research and development and commercialization of technologies are needed in this field.

In India, unlike the developed countries we do not have elevators or lifts in the buildings of rural area. There are still conventional steps are used for steps on the floor. From our point, the energy can be utilized by just placing a unit "Staircase Power Generation system". By placing this system in a rural building or in places like railway stations, so much of energy can be tapped. This consumed energy can be used for the lights on the rural area or the crowded places like railway stations, colleges etc

## III. WORKING PRINCIPLE

This project is concerned with generation of electricity from 'power step' set up. The human load acts upon the

Power step-setup will produce linear reciprocating motion on the power step. Here the reciprocating motion of the power step is converted into rotary motion using the crankshaft arrangement. A flywheel is used to produce rotary motion. The flywheel and the power step pedal are connected by means of connecting rod. The rotary motion of large flywheel is given to the small pulley by belt or chain. Hence the speed that is available at the flywheel is relatively multiplied by the rotation of the smaller pulley.

This speed is sufficient to rotate the rotor of a 12V generator. The rotor which rotates within a static magnetic

## International Journal of Innovative Research in Science, Engineering and Technology

An ISO 3297: 2007 Certified Organization,

Volume 3, Special Issue 1, January 2014

International Conference on Engineering Technology and Science-(ICETS'14)

On 10<sup>th</sup> & 11<sup>th</sup> February Organized by

Department of CIVIL, CSE, ECE, EEE, MECHANICAL Engg. and S&H of Muthayammal College of Engineering, Rasipuram, Tamilnadu, India

stator cuts the magnetic flux surrounding it, thus producing the electro motive force (emf). This generated emf is then sent to an inverter, where the generated emf is regulated. This regulated emf is now sent to the storage battery where it is stored. This current is then used for other purposes.

The generator converts the mechanical rotary motion into electrical energy.

### IV. CONSTRUCTION

The following arrangements are made to make it as a good energy transfer system.

#### A. Stationary Plate:

It is a base plate which is connected to other rigid RCC steps and it provides operating platform for the moving power step by means of bearing support.

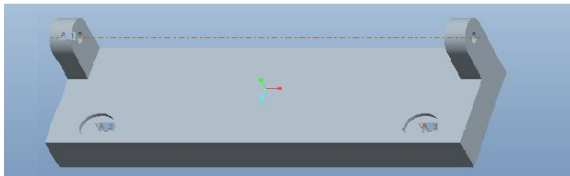

Fig. 1(a)

#### B. Power Step:

It is rectangular Cast Iron plate which is supported by two deep groove ball bearings with stationary plate.

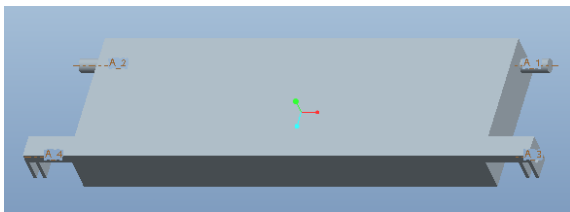

Fig. 1(b)

#### C. Open Coil Helical Spring:

Two compression springs are used to carry the load on the edge of the power step. Springs are also to provided for the continues oscillation of the power step.

#### D. Connecting Rod:

It is to connect the power step and crank shaft. It transmits the linear motion of the power step to the crank.

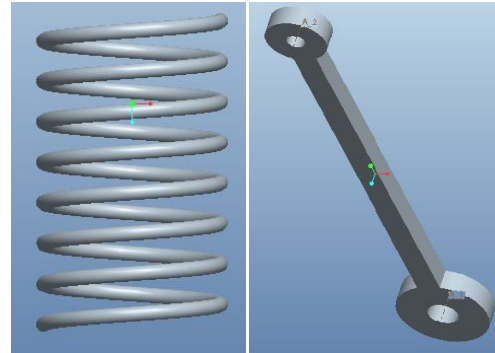

Fig. 1(c)

#### E. Crank Shaft:

One end of the crank shaft is fixed and supported by a ball bearing. Another end is connected to the flywheel.

#### F. Fly Wheel:

The circumference of the flywheel is in the form of pulley type to guide the belt drive which connects the flywheel and generator shaft.

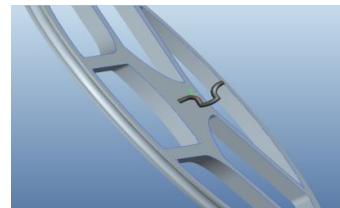

Fig 1(d)

#### G. Belt Drive:

It is to connect the flywheel and the gen shaft. It multiplies the power from the flywheel to the small pulley shaft (generator shaft).

### V. LAYOUT OF THE SYSTEM

#### A. Power step assembled with Base stationary plate:

**International Journal of Innovative Research in Science, Engineering and Technology**

An ISO 3297: 2007 Certified Organization,

Volume 3, Special Issue 1, January 2014

International Conference on Engineering Technology and Science-(ICETS'14)

On 10<sup>th</sup> & 11<sup>th</sup> February Organized by

Department of CIVIL, CSE, ECE, EEE, MECHANICAL Engg. and S&H of Muthayammal College of Engineering, Rasipuram, Tamilnadu, India

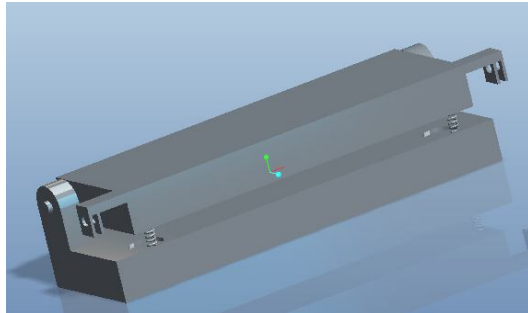

Fig. 2(a)

**B. Schematic working Diagram:**

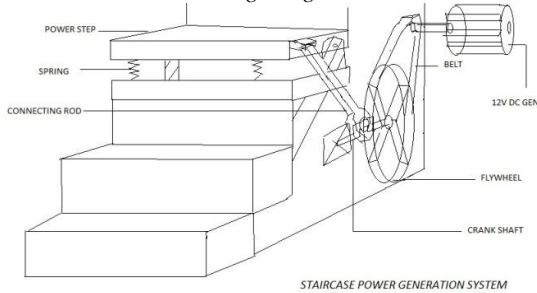

Fig. 2(b)

**C. Photograph of the Experimental Prototype:**



Fig. 2(c)

**D. Block Diagram:**

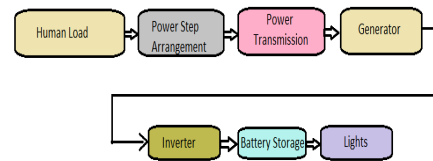

Fig. 2(d)

**V. DESIGN CALCULATION AND OUTPUT RESULTS**

The above setup step is installed in 5 different places of a staircase which has 20 steps.

Max. Load (human load) acts on a power step = 981 N.  
i.e., Avg. Weight of a man = 100 Kg.

Work done = Force x Distance  
Force = Weight of the man

Distance travelled by power step due to linear motion is about 30 mm, which is negligible while stepping.

Distance = 0.06 m  
Therefore,  
Work done = (981 x 0.06)

Work done = 58.86 J  
Output power = Work done/Sec  
= 58.86/60  
= 0.981 Watts (For 1 pushing force)

So the power developed for 1 person passing this power step in a minute = 0.981 Watts.

Power developed for 60 minutes (1 hr) = 0.981 x 60  
= 58.86 Watts

Power developed for 24 hours (1 day) = 58.86 x 24  
= 1.4126 kW

This power is developed in one step only. As we said, if the step is installed in 5 places out of 20 steps, in a building, then the Total generated power = (1.4126 x 5)  
= 7.063 kW

(If this setup works round the clock)

This power is enough to light 9 fluorescent lamps of 36 W in the rural area or crowded places.

\*If this system is installed in 50 buildings of an area, then the power generation will be,  
(0.007063 MW x 50) = 0.35315 MW

## International Journal of Innovative Research in Science, Engineering and Technology

An ISO 3297: 2007 Certified Organization,

Volume 3, Special Issue 1, January 2014

### International Conference on Engineering Technology and Science-(ICETS'14)

On 10<sup>th</sup> & 11<sup>th</sup> February Organized by

Department of CIVIL, CSE, ECE, EEE, MECHANICAL Engg. and S&H of Muthayammal College of Engineering, Rasipuram, Tamilnadu, India

#### VI. EXPERIMENTAL INVESTIGATION

##### A. Voltage generated VS load:

When the load of person passing through the step is increased the voltage generated will increase considerably.

TABLE.1  
LOAD vs VOLTAGE

Load(Human Weight) in kg	Voltage Generated V
50	8
60	9.5
70	10
90	11
100	12
110	12

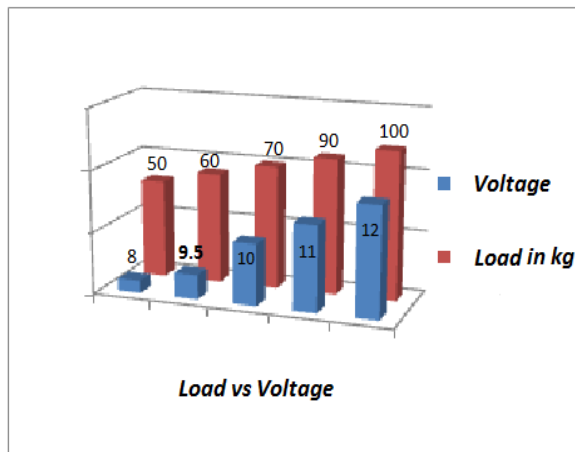

Fig. 3(a)

#### VII. ADVANTAGES

- Simple technology and easy maintenance
- No labour required.
- No fuel required.
- Pollution free power generation.
- This system does not depend on the weather like solar, wind and hydro power generations. So the energy available all around the year.
- This unit has minimum cost of installation.

#### VIII. CONCLUSION

This method generates the electric power without polluting our environment. The waste energy supplied by human is utilized in this system. This energy source is continuous and renewable. Moreover we are confident that this method of power generation will be used for rural

electrification and to fulfil our power needs. Also this system looks very eco-friendly from the environmental point of view.

#### ACKNOWLEDGMENT

We hereby acknowledge that this is our original paper towards the development of power sources in India. We thank our parents, our guide Mr.B.Suresh Kumar, Assistant Professor, Our Head Dr. Srinivasa Raman for helping us to develop this project.

#### REFERENCES

- [1] Mukherjee, Chakrabarti, *Fundamentals of renewable energy systems* New Age international limited publishers, New Delhi, 2005.
- [2] Sharma, P.C., *Non-conventional power plants*, Public printing service, New Delhi, 2003.
- [3] Arora, C.P., *Fundamentals of renewable energy systems*, New Age international limited publishers, New Delhi, 2005.
- [4] PSG Tech, *Design Data*, Kalaikathir printers, Coimbatore 2007
- [5] V B Bhandari, *Design of machine elements*, Tata McGraw-Hill Education publisher, 2010
- [6] *International Journal of Advances in Electrical and Electronics Engineering* ISSN: 2319-1112/IJAEEE