



International Journal of Innovative Research in Computer and Communication Engineering

(An ISO 3297: 2007 Certified Organization)

Vol. 3, Issue 3, March 2015

Video Streaming Over WiMAX with Ant Colony Optimization for Health Applications

S.Suganya¹, R.Ponnulakshmi²

PG Scholar, Department of Computer Applications, Dhanalakshmi Srinivasan Engineering College, Perambalur, Tamilnadu, India.

ABSTRACT: This paper presents a new proficiency WiMAX embodies the IEEE 802.16 family of standards, providing wireless broadband access. With IEEE 802.16e, the mobility amendment and WiMAX guarantees to address the ever-increasing demand of mobile high-speed wireless data in fourth generation (4G) networks. In the existing work, video distribution has been considered as a basic technique that involves scheduling and content-aware video streaming since the video is transmitted as different frames there is a chance of getting either mismatched frames at the receiver or loss of frames owing to incorrect threading of the video frames. Due to these reasons, the expected throughput may not be obtained, to improve the quality of service and to overcome this ailment, the proposed work establish the Ant colony optimization(ACO) prototype.ACO algorithm includes two mechanism: trail evaporation and daemon actions which acts effectively to trigger the accumulation of data being collected at the receiver end. This marches to provide desired QOS and throughput especially in the trait of medical application.

KEYWORDS: IEEE 802.16/WiMAX, MPEG stream, real-time video transmission, scheduling, Healthcare, QOS, ACO Algorithm.

I. INTRODUCTION

WiMAX is a wireless digital communications system, also known as IEEE 802.16 that is intended for wireless metropolitan area networks Support for both Time Division Duplex (TDD), Frequency Division Duplex (FDD) and SS(subscriber station) is provided burst transmission format whose framing mechanism supports adaptive burst profiling in which transmission parameters, including the modulation and coding schemes, may be adjusted individually to each SS on a frame-by-frame basis, thus providing high data rates and its extensively used for the applications like telemedicine, online video gaming, video surveillance, high speed BWA(Broad band wireless Access).

Table.1 WiMAX Services and Applications

Category	Applications	Qos Specifications
UGS Unsolicited Grant Service	VoIP	Maximum Sustained, Rate Maximum Latency, Tolerance, Jitter Tolerance
RTPS	Streaming Video or Audio	Minimum Reversed, Rate, Minimum Sustained, Rate, Maximum Latency, Tolerance Traffic Polarity.
ERTPS	Voice with Activity detection	Minimum Reversed, Rate, Maximum Sustained, Rate, Maximum Latency, Tolerance Traffic Polarity Jitter Tolerance
NRTPS	FTP (File Transfer Protocol)	Minimum Reversed, Rate, Minimum Sustained, Rate, Traffic Polarity
Best Effort Service	Data Transfer, Web browsing, etc.,	Maximum Sustained, Rate Traffic Polarity

International Journal of Innovative Research in Computer and Communication Engineering

(An ISO 3297: 2007 Certified Organization)

Vol. 3, Issue 3, March 2015

This dissertation is categorized as follows. Section II Describes about IEEE 802.16/WiMAX System Evaluation Methodology and Telemedicine Applications. Section III & IV contains Quality of Service and video streaming with ACO, based on IEEE 802.16 Networks. Section V Shows the Simulation Results and Discussions about the projected system.

II. IEEE 802.16/WiMAX SCHEME EVALUATION METHODOLOGY

In Telemedicine Applications Full backward compatibility and interoperability, improving the efficiency are the important attributes required for IEEE 802.16 systems, while the network operator can disable legacy support in green-field deployments its compliant with a subset of the IEEE 802.16 features as specified by the WiMAX Forum. For getting Smooth Migration Backward compatibility is required to interface between new systems Over without affecting the conventional System. Due to maintaining the full Backward Compatibility it preserves the required bandwidth for Multi antenna mode, the next generation WiMAX will be capable of over air data transfer Rates in excess amount of supporting a broad range also provide high quality and high capacity IP-based services and applications.

The IEEE 802.16 supports multiple traffic flows with diverse channel characteristics. The use of advanced antenna techniques and flexible sub channelization enables the system to support peak Downlink (DL) it's comprehensively used to supports both fixed and mobile services for enterprise and consumer markets. The emerging trends of high Speed internet and Multimedia, video broadcasting applications have led to be need for WiMAX. Figure 1 shows the network reference model for WiMAX.

Figure.1 shows the WiMAX Network Reference Model it's specifying a non-hierarchical, end-to-end network for

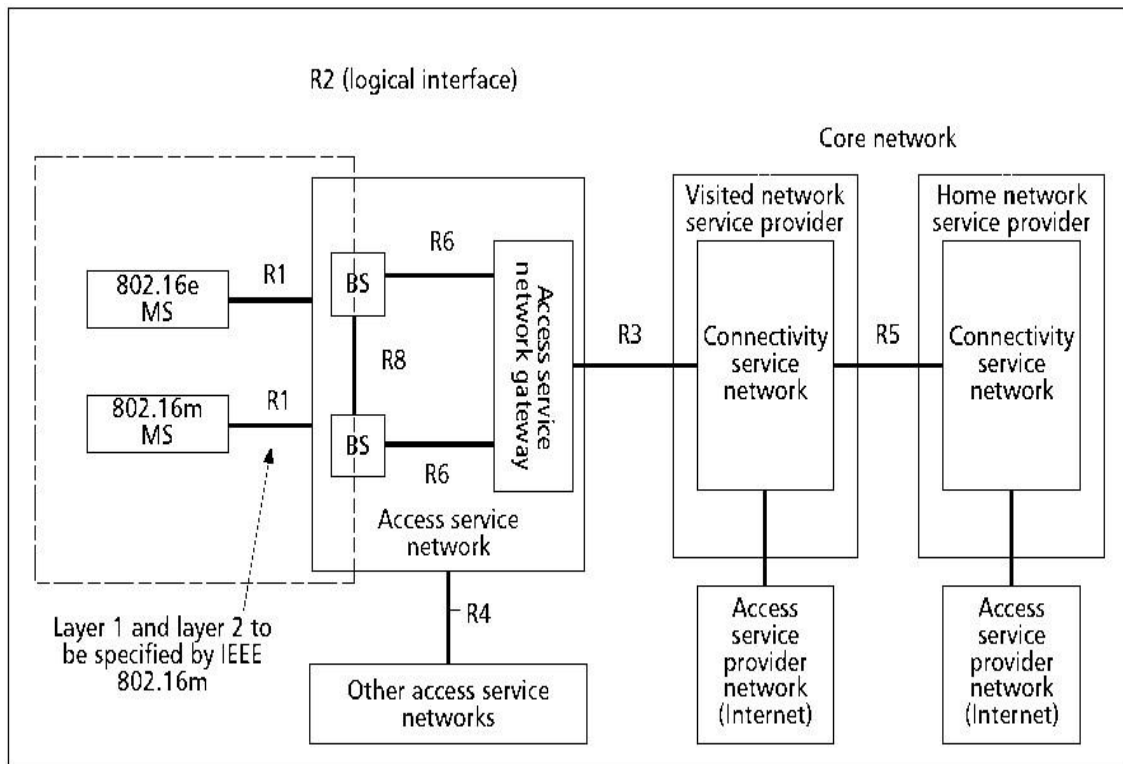

Figure.1 WiMAX Reference Model



International Journal of Innovative Research in Computer and Communication Engineering

(An ISO 3297: 2007 Certified Organization)

Vol. 3, Issue 3, March 2015

WiMAX. That can be expanded to perform optional relay entities for coverage and performance enhancement in upcoming releases. The IEEE 802.16 standard describes Medium-access-control (MAC) and physical layer (PHY) protocols for fixed and mobile Broadband wireless-access systems. The MAC and Physical functions can be classified into three Categories, namely, data plane, control plane, and management plane. The data plane comprises Functions in the data processing path Such as header compression, as well as MAC components, and PHY data packet-processing functions. A set of layer-2 (L2) control functions is mandatory to support various radio resource configuration, Coordination, signaling, and management. This set of functions is communally referred to as the control-plane functions. A management plane also is defined for external management and system configuration. WiMAX Architecture provide flexibility for different applications, the standard supports two major exploitation circumstances:

Last-mile Broadband Wireless Access: In these present surroundings, broadband wireless connectivity is interface between home and business users in a WMAN environment. The function is based on a point-to-multipoint single-hop transmission along with a single base station (BS) and multiple subscriber stations (SSs).

Backhaul networks: WiMAX network works as a backhaul for cellular networks to transport data/voice traffic from the cellular edge to the core network (Internet) through meshing among IEEE 802.16/WiMAX Subscriber Stations. The major components in the telemedicine systems are data acquisition, processing, and storage. The personal medical information system (PMIS) servers are used to stockpile patients' personal and diagnostic data in the system. These servers are connected to the hospital intranet to provide local access as well as remote access to the doctors. Telemedicine services with applications in emergency healthcare, telecardiology, telecardiology, telepathology, teledermatology, and tele-oncology have become popular to provide prompt and effective patient care. IEEE 802.16/WiMAX technology for wireless telemedicine/e-health services provides high bandwidth, security, high quality of service and integrated services. The MAC layer security aspect in the IEEE 802.16/ WiMAX standard can provide access control and encryption functionalities for wireless telemedicine services.

III. QoS PROVISION IN WiMAX NETWORKS

This section reviews the basic MAC contrivances defined by 802.16 which are specifically interrelated to QoS provisioning. QoS refers to the "collective effect of service" as perceived by the user. The 802.16 standard postulates two modes for allocating the wireless medium: point-to-multipoint (PMP) and mesh.

The following parameters must be considered in order to develop an efficient QoS

- **QoS Requirements:** To allocate resources efficiently, the algorithm should have the Capability to handle multiple traffic flows and real time services.
- **Connection Admission Control:** The users are admitted only if the available Bandwidth can accommodate the expanded traffic. Otherwise, access to the network is denied.
- **Radio Resource Management:** Bandwidth is utilized efficiently in order to improve the effectiveness and reliability of wireless transmission.
- **Fairness:** The WRQ algorithm should fairly allocate resources to non-priority queues.
- **Flexibility:** The scheduling algorithm should be backward-compatible so that it can be deployed onto various networks with diverse QoS requirements.

The IEEE 802.16e standard defines only two layers: physical (PHY) layer and MAC layer. The PHY layer is responsible for the actual transmission of bits onto the air Interface between peer units, while the MAC inaugurates and continues the connection between the communication devices. PHY layer include encoding and decoding of signals, preamble generation, modulation and Demodulation, bit transmission and reception, regulation of transmission power, and numerous other characteristics. It supports both LOS (line of sight) and NLOS (Non line of sight) communication with specified frequency ranges. OFDM (Orthogonal Frequency Multiplexing) is one of the modulation techniques introduced to eliminate ISI (Inter Symbol Interference) and loss of power in WiMAX. OFDM is based on frequency division multiplexing (FDM), which uses multiple frequencies to transmit signals in a parallel configuration. All sub-carriers are orthogonal to each other and the choice of carrier spacing is reciprocal to symbol time.

International Journal of Innovative Research in Computer and Communication Engineering

(An ISO 3297: 2007 Certified Organization)

Vol. 3, Issue 3, March 2015

The IEEE 802.16 MAC layer is designed to support PMP and mesh networks. In mesh networks, the SS (subscriber station) communicates with each other directly rather than having to go through the BS (Base station). It provides a connection-oriented service creation to the upper layer service. All service connections entering the MAC layer are identified by a unique, 16-bit Connection ID (CID). Two operations take place at the CS layer: the CS layer classifies the incoming packet, depending on the IP protocol and priority parameters, and sends it to the corresponding CID. The unidirectional connections between the BS and SS can transport service flow traffic and control the air interface. The connection is for one type of service. For example, file transfer and multimedia applications cannot be sent on the same CID.

The service flow, identified by a 32-bit ID known as the Service Flow ID (SFID), provides unidirectional transport of data packets. The service flow characteristics define the QoS parameters of each connection. At the MAC layer, the standard provides three main methods of QoS provisioning: Service Flow Classification, Dynamic Service Establishment, and the Two-Phase Activation Model. Figure 2 shows the QoS functions within BS and SS in IEEE 802.16 networks.

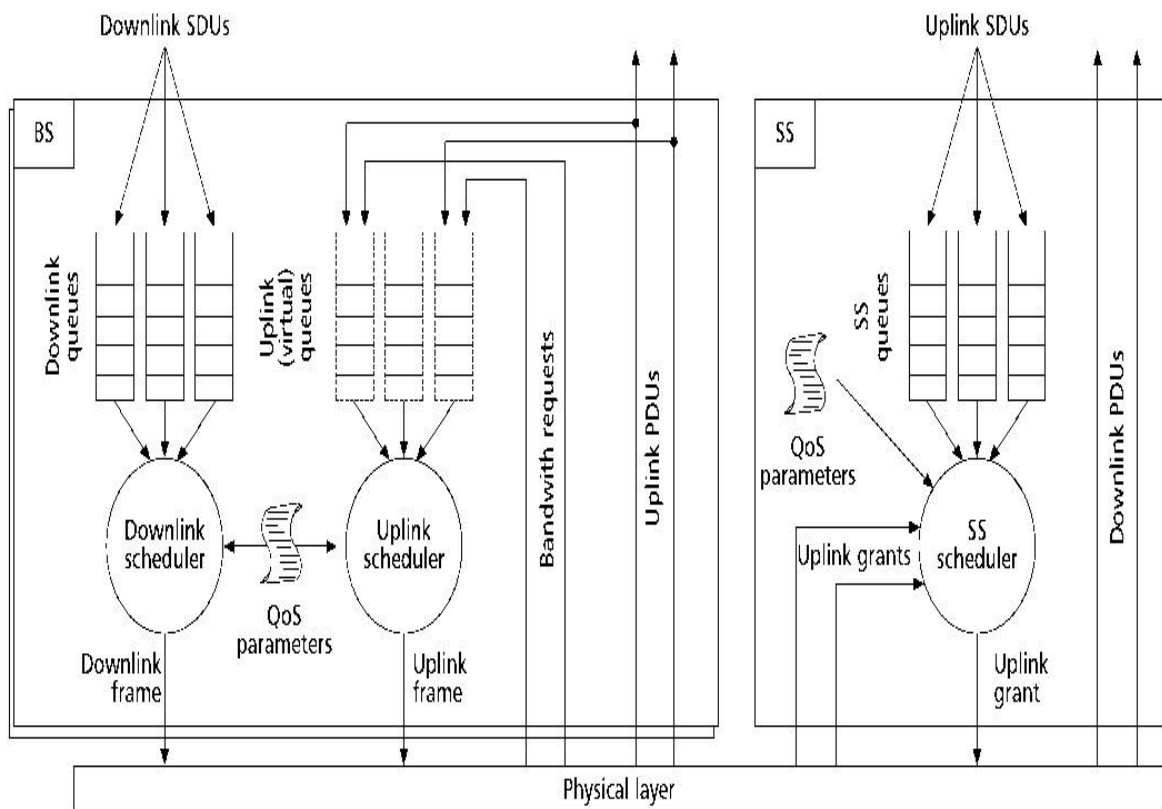

Figure.2 QoS tasks within BS and SS Architecture

Bandwidth requests are used on the BS for reckoning the Residual excess of uplink connections. Scheduling is to allocate the available resource (e.g., time slot and sub channel) to the on-going and the incoming links so that the required QoS can be guaranteed. Also, the offered resource should be allotted in a fair manner among the SSs/connections. In IEEE 802.16, there are two modes of bandwidth allocation (i.e., GPC and GPSS modes) that work on a per connection and per SS basis, respectively. Therefore, the radio resource management and scheduling mechanism need to be deliberate at both the SS and BS. At an SS, while queue-aware bandwidth allocation is used to allocate bandwidth according to the QoS necessities, rate control is used to avoid congestion. Earliest deadline first (EDF) and weight fair queue (WFQ) scheduling schemes are used in IEEE 802.16e. Some of QoS parameters



International Journal of Innovative Research in Computer and Communication Engineering

(An ISO 3297: 2007 Certified Organization)

Vol. 3, Issue 3, March 2015

defined for wireless applications include bandwidth, jitter, throughput, delay, packet error rate, etc. To meet the requirements of real-time applications and to enforce differentiated service to users, a QoS mechanism is necessary.

IV. VIDEO STREAMING WITH ANT COLONY OPTIMIZATION

Video is a collection of consecutive still images displayed one after another with a set frequency to give the appearance of motion. The fundamental parameters of a digital video are frame rate, resolution, bit rate and aspect ratio. Frame rate relates to the number of still images or frames to display per second (fps). MPEG-4 standard has greater flexibility, which is used in Telemedicine applications. Streaming is the turn of playing out a file on a client station while it is still being aggressively downloaded from the source or server. It can be applied to video and audio media as well as other forms of data streams as live data. The sum of bandwidth required by different types of streams can vary intensely. Video streaming places an onerous requirement for bandwidth on a network based on its Frame rate, resolution and bit rate.

User Datagram Protocol (UDP), send the media stream as a series of small packets, packets are liable to be lost or corrupted in transit. Depending on the protocol and the extent of the loss, the client may be able to recover the data with error correction techniques. RSVP session is established at the IP layer, an equivalent resource reservation can be established at the MAC layer using the Dynamic Service Addition (DSA) mechanism. The RTSP is a client server multimedia presentation control protocol, designed to address the needs for client delivery of streaming multimedia over IP Networks. Video streaming in pull mode works with RTSP protocol. There are standard RTSP messages to initiate the streaming process. RTSP OPTIONS is sent from client to fetch the possible command options offered with the server.

RTSP DESCRIBE is used to request the URL for streaming. SVC standard will specify how to represent video streams with spatial, temporal and quality scalability; indeed it is possible to generate SVC enhancement layers which can augment an H.264/AVC compatible base layer. Interruptions occur when the Streaming client's play-out buffer drains completely and happens because of severe and persistent congestion in the network. Therefore, limiting the amount of data that is in the network, as accumulation-based congestion control mechanisms also help to prevent the client's play-out buffer from draining during a streaming session.

End-to-end feedback mechanism between streaming server and client without additional complication to the management message transfers before introducing the streaming session. Mapping of the feedback message between IP and MAC level QoS parameters to provide true end-to-end quality assurance in WiMAX. Link layer feedback mechanism provides enough bandwidth for the streaming session so that there won't be significant network loss in the wireless medium. There is a huge loss in perceptual quality of video even when 10% of the frames are lost. Figure 3 shows the Framework model for video streaming over WiMAX.

International Journal of Innovative Research in Computer and Communication Engineering

(An ISO 3297: 2007 Certified Organization)

Vol. 3, Issue 3, March 2015

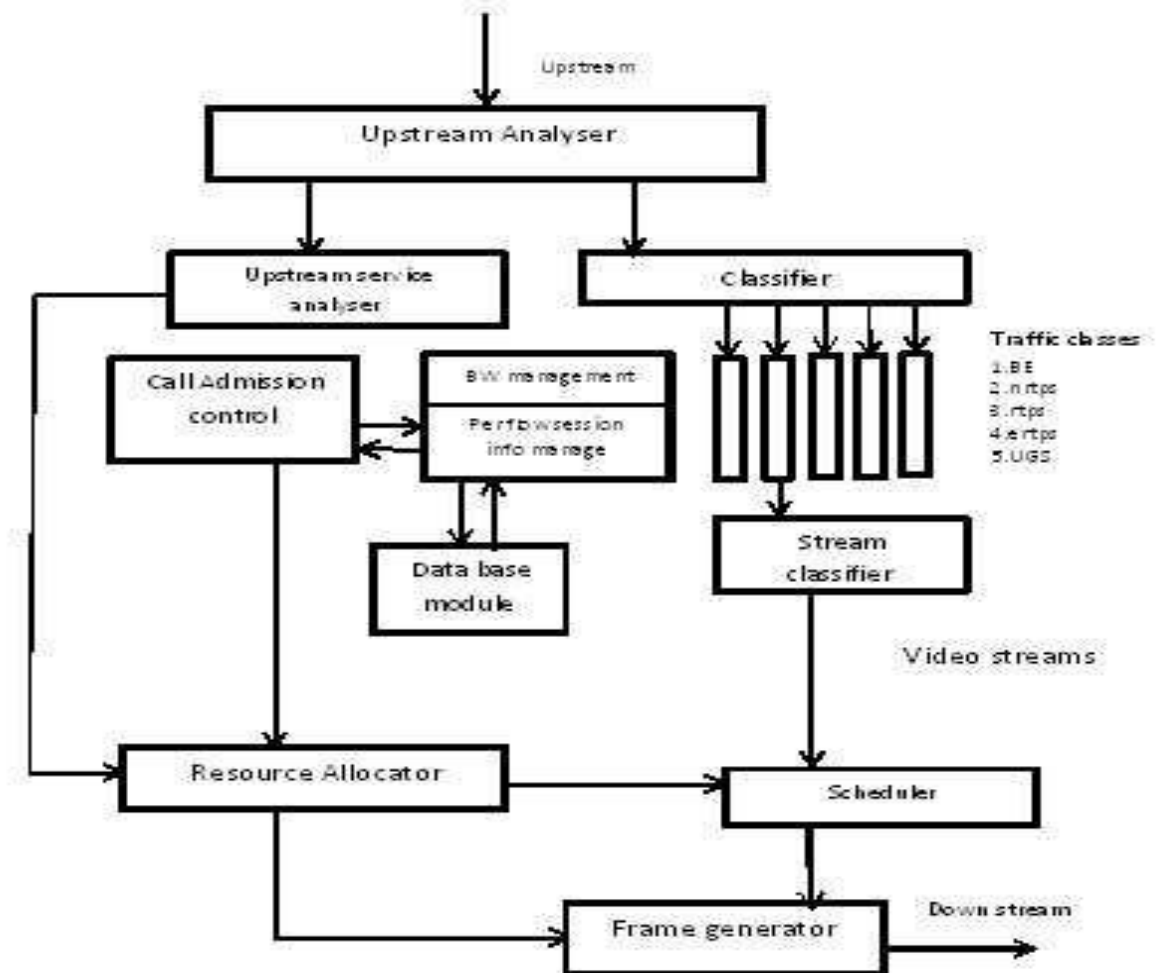

Figure 3. Frame Work model for video streaming Through WiMAX

The following mapping scheme is universally accepted for transferring E-Health data over WiMAX network.

1. Allocate Unsolicited Grant Service (UGS) type of QoS to the bio signal traffic and voice. Conversation.
2. Real-time Priority Service (rtPS) service for the video transmission.
3. Non-real-time Priority Service (nrtPS) to the file transfer, such as x-ray images and Ultrasound results..
4. Best Effort (BE) service class is to be allocated for the database access

During the Video transmission there is a chance of getting either mismatch or loss of frames that owing to affect the network parameters. It leads to diminish the QOS. To avoid those problems ANT COLONY optimization is used it increase the throughput and improves the QOS of the video streaming from the Existing novel method.

V. SIMULATION RESULTS AND CONCLUSION

This section shows the simulation results of video streaming over WiMAX with different Wireless parameters and its graphical representation. Simulation Parameter specifications

International Journal of Innovative Research in Computer and Communication Engineering

(An ISO 3297: 2007 Certified Organization)

Vol. 3, Issue 3, March 2015

Parameters	Range
Simulation time	300s
Placement of nodes	Random
Modulation	64QAM
MAC protocol	IEEE 802.16e/m
Multiple Access scheme	OFDMA
Routing Protocol	AODV
Antenna Model	Omnidirectional
Video Streaming protocol	RTCP and RTP

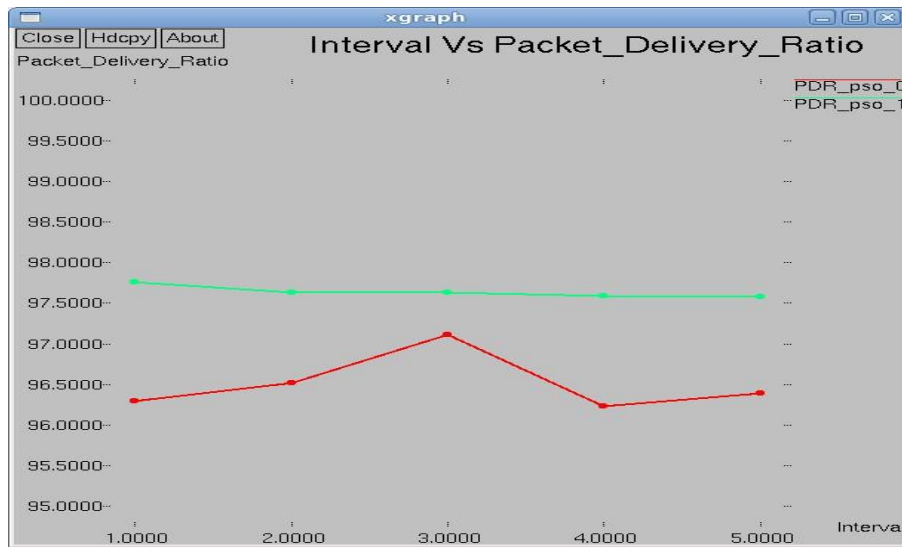

Figure.4 interval vs packet Delivery ratio with different kind of WiMAX traffic

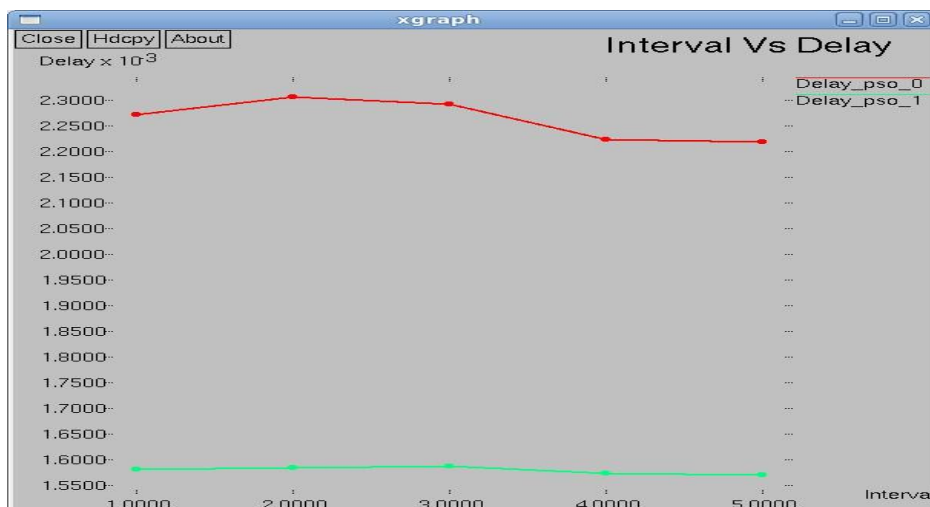

Figure 5. Interval vs delay

International Journal of Innovative Research in Computer and Communication Engineering

(An ISO 3297: 2007 Certified Organization)

Vol. 3, Issue 3, March 2015

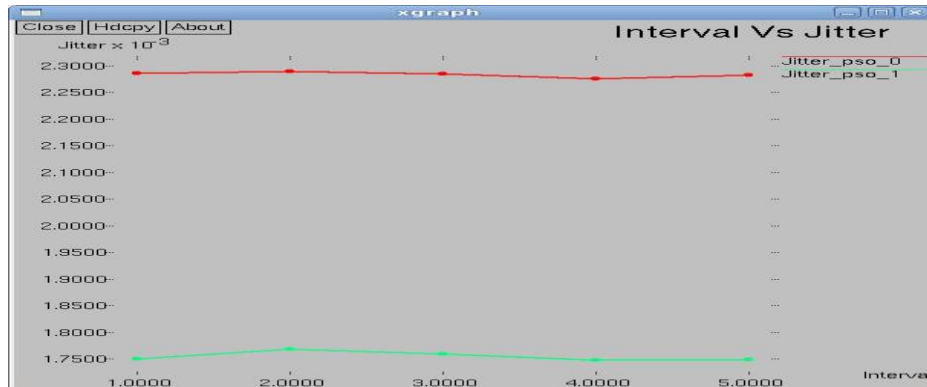

Figure 6. Interval vs jitter

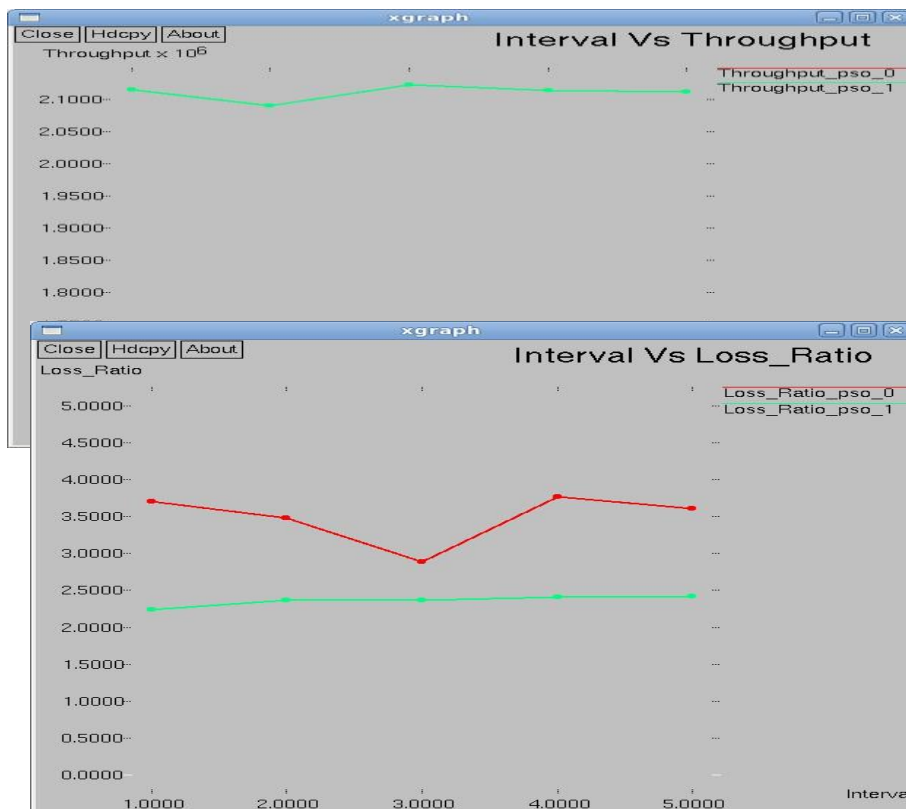

Figure 7. Interval vs throughput

VI. CONCLUSION

From the simulation result presented in section V it provides the better QoS with ANT colony optimization technique. ACO avoid the frame loss in video transmission and offers desired QoS improve the overall network throughput, over WiMAX for Tele medicine applications. In future planned to create the novel ideo distribution technique with scheduling and PSO optimization for cardiology base surgeries through teleconferencing.



International Journal of Innovative Research in Computer and Communication Engineering

(An ISO 3297: 2007 Certified Organization)

Vol. 3, Issue 3, March 2015

REFERENCES

- [1] G. Markarian, D. Tsitserov, and A. Zvikhachevskaya, "Novel technique for efficient video distribution over WiMAX networks," presented at the 21st Annu. IEEE Int. Symp. Personal, Indoor Mobile Radio Commun, Istanbul, 2010.
- [2] J. G Andrews, Fundamentals of WiMAX: Understanding Broadband Wireless Networking (Communications Engineering and Emerging Technologies Series). Englewood Cliffs, NJ: Prentice Hall, 2007.
- [3] D. Niyato, E. Hossain, and J. Diamond, "IEEE 802.16/WiMAX-based broadband wireless access and its application for telemedicine/e-health services," IEEE Wireless Commun., vol. 14, no. 1, pp. 72–83, Feb. 2007.
- [4] A. Zvikhachevskaya, G. Markarian, and L. Mihaylova, "QoS consideration for wireless telemedicine/e-health services," in Proc. IEEE Wireless Commun. Netw. Conf., Budapest, Hungary, 2009, pp. 1–6.
- [5] R. S. H. Istepanian, S. Laxminarayn, and C. S. Pattichis, M-HEALTH: Emerging Mobile Health Systems. London: Springer-Verlag, 2006.
- [6] N. Y. Philip, "Medical quality of service for optimised ultrasound streaming in wireless robotic tele-ultrasonography system Inf. Syst., Kingston Univ., 2008.
- [7] Overview of the MPEG-4 Standard, ISO/IEC JTC1/SC29/WG11, N4668, Mar. 2002.
- [8] G. Markarian, "Wireless broadband communications for video surveillance Trends, problems and solutions (invited tutorial)," in Proc. 13th Int. Symp. Wireless Personal Multimedia Commun., Oct. 11–14, 2010, wireless
- [9] J. Chen, C.-C. Wang, F. C.-Da Tsai, and C.-Wei Chang, "The design and implementation of WiMAX module for ns-2 simulator," presented at the WNS2'06 Conf., Pisa, Italy, Oct. 10, 2006.

BIOGRAPHY



SUGANYA.S - Received B.C.A, in Cauvery College For Women, Trichy, Affiliated to Bharathidasan University. Currently Doing M.C.A in Department of Computer Applications, Dhanalakshmi Srinivasan Engineering College, Perambalur, TamilNadu. India. Affiliated to Anna University.. Research areas are Networking, Web Technology, and Mobile Computing.



PONNULAKSHMI.R - Received B.C.A, In Indira Gandhi College, Trichy, Affiliated to Bharathidasan University. Currently Doing M.C.A in Department of Computer Applications, Dhanalakshmi Srinivasan Engineering College, Perambalur, TamilNadu. India. Affiliated to Anna University. Affiliated to Anna University.. Research areas are Networking, and Image Processing..