



International Journal of Advanced Research in Electrical, Electronics and Instrumentation Engineering

(An ISO 3297: 2007 Certified Organization)

Vol. 3, Special Issue 2, April 2014

CONTROL OF DOUBLY FED INDUCTION GENERATOR BASED WIND ENERGY CONVERSION SYSTEM

R.Rajeswari

PG Student, Research Scholar, Dept. of Electrical and Electronics Engineering, College of Engineering Guindy,
Anna University, Chennai, India

ABSTRACT - Doubly-Fed Induction Generator (DFIG) based wind turbine with is gaining laurels in the growing wind market. By means of a bidirectional converter in the rotor circuit the DFIG is able to work as a generator in both sub-synchronous and super-synchronous modes. DFIG is connected with back-to-back converters. In general, VAR compensation is a major problem in WECS. Capacitors banks are to be added in parallel to the machine which leads to many problems such as over voltages etc. In this project, the grid side converter itself compensates for the reactive power rather than providing an additional compensating device. Additional power is also extracted from the rotor side. The machine-side converter controls the rotor speed by using the v/f control technique while the grid-side converter controls the dc-link voltage and ensures the operation by making the reactive power drawn by the system from the utility to zero by using the voltage-oriented control technique. The grid-side current is controlled by using reference current generation in p-q theory. The performance of DFIG is analyzed during the operation of sub-synchronous and super-synchronous generating modes using MATLAB/SIMULINK.

INDEX TERMS – doubly-fed induction generator (DFIG), wind energy conversion systems (WECS), voltage oriented control (VOC), p-q theory, utility grid, rotor side converter (RSC), grid side converter (GSC).

1. INTRODUCTION

Now-a-days, the consumption of conventional energy sources has increased, So efforts have been made to generate electricity from renewable energy sources such as wind, solar etc., Wind energy has become one of the most important and promising sources of renewable energy. This demands additional transmission capacity and better means of maintaining system reliability. Today the wind power capacity of the world is approximately 50GW and it is expected to reach 160GW by 2012. In modern Wind Turbine Generation System (WTGS), the wind turbines are subjected to variation of load and impact of sudden wind speed variations.

With increased penetration of wind power into electrical grids, Doubly-Fed Induction Generator (DFIG) wind turbines are largely deployed due to their variable speed feature and hence influencing system dynamics. This has created an interest in developing suitable models for DFIG to be integrated into power system studies. The continuous trend of having high penetration of wind power, in recent years, has made it necessary to introduce new practices. Additionally, in order to model power electronic converters, in the simplest scenario, it is assumed that the converters are ideal and the DC-link voltage between the converters is constant. Consequently, depending on the converter control, a controllable voltage (current) source can be implemented to represent the operation of the rotor-side of the converter in the model.

In the literature, ManasiPattnaik, “Study of Doubly-Fed Induction Generator for variable Speed Wind Energy Conversion Systems”, gives brief idea about the operation and working of DFIG.[1].F. Poitiers, M. Machmoum, R. Le Doeuff and M.E. Zaim, “Control Of A Doubly-Fed Induction Generator For Wind Energy Conversion System”, gives information about the modeling of the DFIG and the control operation used.[2].R. Pena, J.C Clare and G.M Asher (1996), “Doubly Fed Induction Generator using back-to-back PWM converter and its application to variable-speed wind-energy generation”, describes the rotor side converter control of DFIG which provides the reference waveform for rotor side converter and the pulses for RSC have been obtained with this the real and reactive power can be controlled.[3].T.Thiringer, A.Petersson, and T.Petru (2003), “Grid



International Journal of Advanced Research in Electrical, Electronics and Instrumentation Engineering

(An ISO 3297: 2007 Certified Organization)

Vol. 3, Special Issue 2, April 2014

Disturbance Response Of Wind Turbine Equipped With Induction Generator and Doubly-Fed Induction Generator”, gives brief idea about the grid disturbance response to fixed speed wind turbines and wind turbines with DFIG are presented.[4].A.Petersson, L.Harnefors, and T.Thiringer (2005), “Evaluation OF Current Control Methods For Wind Turbines Using Doubly-Fed Induction Machine,” gives brief idea about the analysis of the stator-flux oriented current control of the DFIG.[5].CarlesBatlle,ArnauD’oria-Cerezo ,Romeo Ortega (2006) , “A Robustly Stable PI Controller for The Doubly-Fed Induction Machine”, this paper gives the brief idea about the closed loop of the system using the PI controller.

II. DOUBLY FED INDUCTION GENERATOR

2.1 INTRODUCTION

Wound rotor induction generators (WRIGs) are provided with three phase windings on the rotor and on the stator. They may be supplied with energy at both rotor and stator terminals. Hence they are called doubly-fed induction generators (DFIGs) or double output induction generators (DOIGs) in the generator mode. Both motoring and generating operation modes are feasible, provided the power electronic converters that supply the rotor circuit via slip-rings and brushes are capable of handling power in both directions.

2.2 OPERATING PRINCIPLE OF DFIG

The mainstream high-power wind-energy conversion systems (WECSs) are based on doubly-fed induction generators (DFIGs). The stator windings of DFIGs are directly connected to the grids, and rotor windings are connected to the grids through back-to-back power electronic converters. The back-to-back converter consists of two converters, i.e., rotor side converter (RSC) and grid side converter (GSC) that are connected “back-to-back.” Between the two converters a dc-link capacitor is placed, as energy storage, in order to keep the voltage variations in the dc-link voltage small. Control of the DFIG is more complicated than the control of a standard induction machine. In order to control the DFIG the rotor current is controlled by a power electronic converter.

Wind turbines use a DFIG consisting of a WRIG and an AC/DC/AC power electronic converter. The stator winding is connected directly to a 3-phase, 50Hz grid while the rotor is fed at variable frequency through the AC/DC/AC converter via slip-rings to allow DFIG to operate at variable speeds in response to changing wind speeds as shown in Fig.1. A typical application, for DFIG is wind turbines, since they operate in a limited speed range of approximately 20-25%. Other applications for DFIG system are flywheel energy storage system, pumped storage power plants and so on.

The total system is that the machine-side converter controls the speed, while the grid-side converter controls the dc-link voltage and ensures the operation at unity power factor (i.e. zero reactive power). By means of a bidirectional converter in the rotor circuit the DFIG is able to work as a generator in both sub-synchronous and super-synchronous modes. Depending upon the operating condition, power is fed in to or out of the rotor (which is the case of super synchronous mode), then it flows from the rotor via the converter to the grid.

International Journal of Advanced Research in Electrical, Electronics and Instrumentation Engineering

(An ISO 3297: 2007 Certified Organization)

Vol. 3, Special Issue 2, April 2014

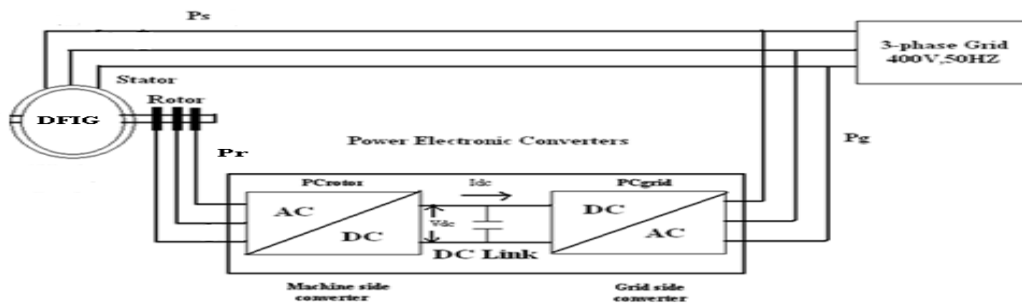

Fig.1. DFIG system with power electronic converters

PC_{rotor} is used to generate or absorb the power P_g in order to keep the dc voltage constant as shown in Fig.1. In steady-state for a lossless AC/DC/AC converter, P_g is equal to P_r and the speed of the wind turbine is determined by the power P_r absorbed or generated by PC_{rotor} . The phase-sequence of the ac voltage generated by PC_{rotor} is positive for sub-synchronous speed and negative for super-synchronous speed. The frequency of this voltage is equal to the product of the grid frequency and the absolute value of the slip. PC_{rotor} and PC_{grid} have the capability for generating or absorbing reactive power and could be used to control the reactive power or the voltage at the grid terminals. Fig.1 Shows the DFIG System With Power Electronic Converters.

2.3 CHARACTERISTICS OF THE DFIG

As a renewable resource, wind has several important characteristics including that it is hard to predict and that its direction and speed vary quickly and randomly. These features complicate the process of converting energy from wind to electricity.

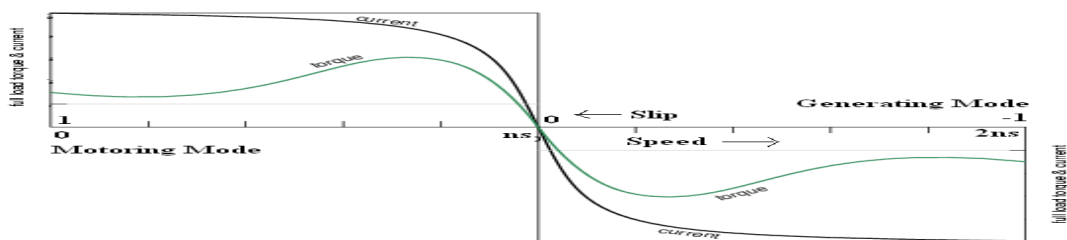

Fig. 2. Torque-Speed characteristics of the DFIG

The negative value of the slip implies running the machine above synchronous speed in the direction of the rotating field. As the torque direction is simultaneously reversed (opposite to the direction of the rotating field), the machine has to be driven by a source of mechanical power to counteract the opposing torque. In the process the machine acts as a generator feeding power to the source. For $s > 1$, the machine runs in a direction opposite to that of the rotating field and the internal torque. In order to sustain this condition, the machine should also be driven by a mechanical power source. This mode of operating the induction machine is known as plugging and is equivalent to an electrical braking method.

International Journal of Advanced Research in Electrical, Electronics and Instrumentation Engineering

(An ISO 3297: 2007 Certified Organization)

Vol. 3, Special Issue 2, April 2014

III. CONTROL SCHEME

3.1 INTRODUCTION

In WECS, the machine draws reactive power initially to start with. Hence VAR compensation is a major issue in WECS. Capacitor banks, if added in parallel to machine may lead to over-voltages. If an additional compensating device such as STATCOM/SVC etc., are added may lead to complexity in control and may cause uneconomic expenses.

In this system, DFIG with back-to-back converter, the grid-side converter itself acts as a compensating device and maintains UPF at grid side. Various control techniques are reported of which voltage oriented control and reference current generation control is simple and ease to implement.

3.2 VOLTAGE ORIENTED CONTROL (VOC)

The grid connected inverter can be controlled with various schemes. One of the schemes is known as voltage oriented control (VOC), as shown in figure.3.1. This scheme is based on transformation between the abc stationary reference frame and dq synchronous frame. The control algorithm is implemented in the grid-voltage synchronous reference frame, where all the variables are of DC components in steady state. This facilitates the design and control of the inverter.

To realise the VOC, the grid voltage is measured and its angle θ_g is detected for the voltage orientation. This angle is used for the transformation of variables from the abc stationary frame to the dq synchronous frame through the abc/dq transformation or from the synchronous frame back to the stationary frame through the dq/abc transformation as shown in fig.3.1. Various methods are available to detect the grid voltage angle θ_g . Assuming that the grid voltages, v_{ag} , v_{bg} , v_{cg} are three phase balanced sinusoidal waveforms, θ_g . Can be obtained by,

$$\theta_g = \tan^{-1} v_{\beta} / v_{\alpha}$$

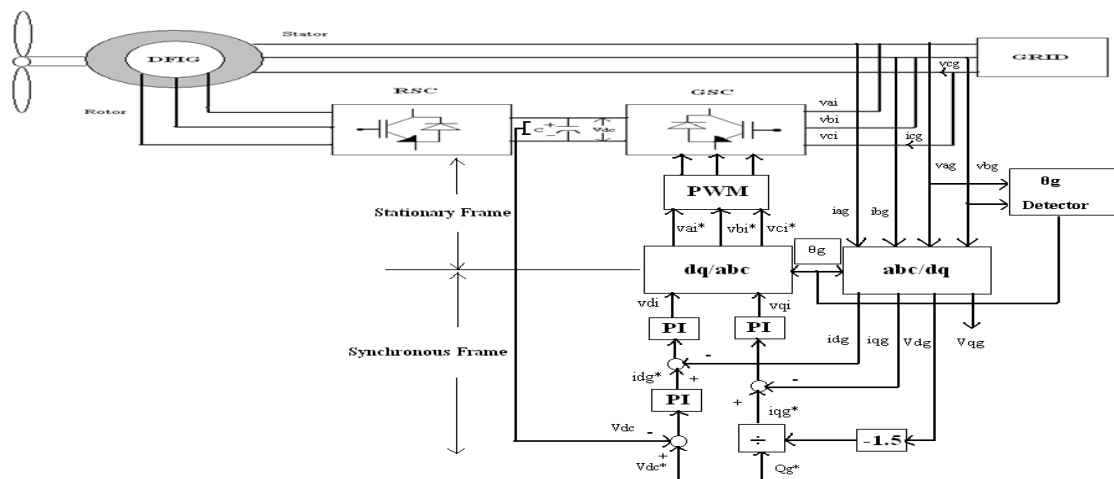

Fig. 3. Block Diagram Of Voltage-Oriented Control

International Journal of Advanced Research in Electrical, Electronics and Instrumentation Engineering

(An ISO 3297: 2007 Certified Organization)

Vol. 3, Special Issue 2, April 2014

The above equation indicates that there is no need to measure the phase-c grid voltage v_{cg} shown in fig.3.1. In practice, the grid voltage may contain harmonics and be distorted, so digital filters or phase-locked loops (PLLs) may be used for the detection of grid voltage angle θ_g .

where Q_g^* is the reference for the reactive power, which can be set zero for unity power factor operation, a negative value for leading power factor operation, or a positive value for lagging power factor operation.

3.3 REFERENCE CURRENT GENERATION CONTROL

Regarding to the quantity that has to be measured and analyzed in order to generate the current reference signal of the (shunt) active filter control system, there are three kinds of strategies:

- (i) load current detection.
- (ii) supply current detection.
- (iii) voltage detection.

Load current detection and supply current detection are recommended for shunt active filters working locally, for individual non-linear high-power consumers. Voltage detection is suggested for: (a) shunt active filters functioning in complex equipment's (so called "unified power quality conditioner"), whose destination is to equip the primary distribution substations; (b) shunt active filters located in the distribution system and supported by utilities. Also the series active filters are mostly based on supply current detection. There are mainly two kinds of control strategies for analyzing and extracting current or voltage harmonics from the distorted waveforms.

- (i) **frequency-domain:** based on the Fourier analysis in the frequency-domain;
- (ii) **time-domain:** based on the theory of instantaneous reactive power in the three-phase circuits and oftencalled p-q theory.

In 1983, Akagi etc all have proposed the "The Generalized Theory of the Instantaneous Reactive Power in Three-Phase Circuits", also known as instantaneous power theory, or p-q theory. The p-q theory consists of an algebraic transformation (Clarke transformation) of the three-phase voltages and currents in the a-b-c coordinates to the a-β-0 coordinates, followed by the calculation of the p-q theory instantaneous power components.

$$p = v_a i_a + v_b i_b + v_c i_c$$

The relation of the transformation between each component of the three phase power system and the orthogonal coordinates are expressed in space vectors shown by the following equations in terms of voltage and current as shown in above equation. This instantaneous reactive theorem performs instantaneously as the reactive power is detected based on the instantaneous voltages and currents of the three phase circuits.

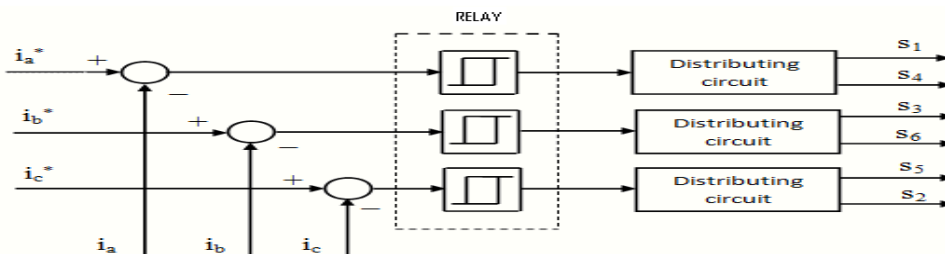

Fig.4. block diagram of current control

Basic p-q theory has proven to be inaccurately when the load voltage system is distorted and/or unsymmetrical. In order to compensate the limitations, the method has been improved and extended.

International Journal of Advanced Research in Electrical, Electronics and Instrumentation Engineering

(An ISO 3297: 2007 Certified Organization)

Vol. 3, Special Issue 2, April 2014

IV. SIMULATION RESULTS

The DFIG machine modes of operation namely sub-synchronous generating, super-synchronous generating are simulated and the waveforms for speed and stator, rotor power and torque in each of the above modes of operation are presented. The rotor speed is controlled by using v/f control and grid-side reactive power & V_{dc} are controlled by using voltage oriented control techniques. The grid-side current is controlled by using reference current control techniques under p-q theory.

4.1 SUB-SYNCHRONOUS GENERATING MODE

In sub-synchronous generating mode the rotor power is injected into the machine in order to make the air gap power as constant. Since the slip is positive in sub-synchronous operation mechanical power is lower than air gap power ($P_m < P_{ag}$).

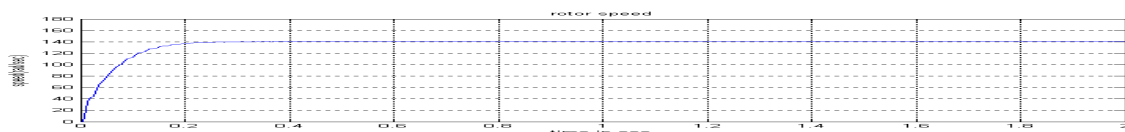

Fig.5. Speed output waveform

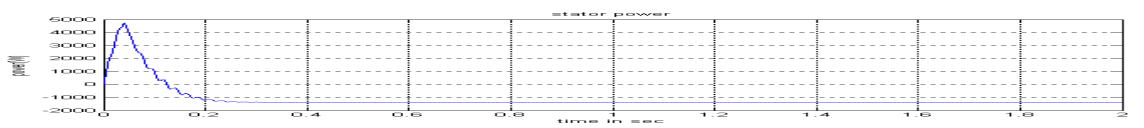

Fig.6.

Stator power waveform

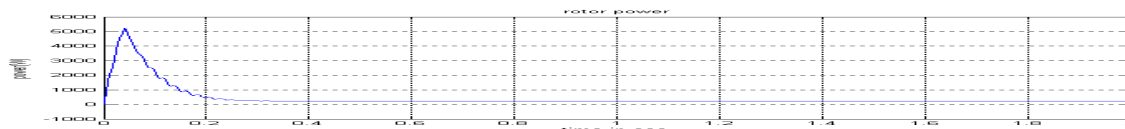

Fig.7. Rotor power waveform

4.2 SUPER-SYNCHRONOUS GENERATING MODE

In super-synchronous generating mode the rotor power is taken out of machine in order to make the air gap power as constant. Since the slip is negative in super-synchronous operation mechanical power is greater than the air gap power ($P_m > P_{ag}$).

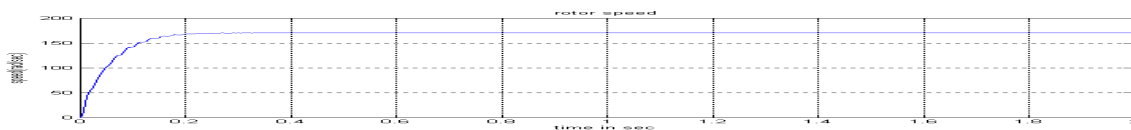

Fig.8. Speed output waveform

International Journal of Advanced Research in Electrical, Electronics and Instrumentation Engineering

(An ISO 3297: 2007 Certified Organization)

Vol. 3, Special Issue 2, April 2014

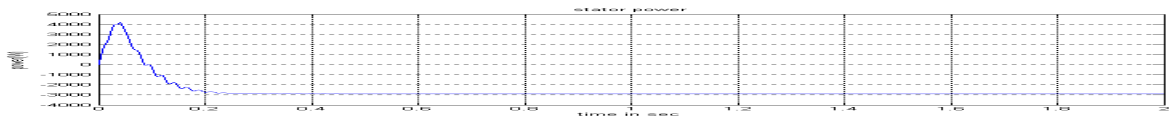

Fig.9. Stator power waveform

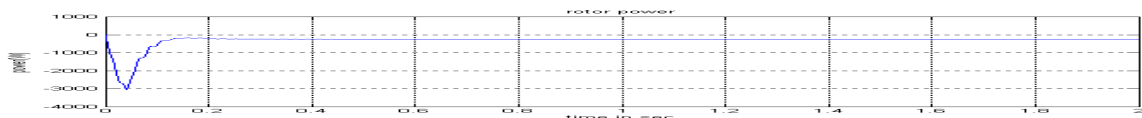

Fig.10. Rotor power waveform

4.3 SIMULATION RESULTS FOR VOLTAGE ORIENTED CONTROL SCHEME

The main objective of the grid side converter is to maintain dc-link voltage constant for necessary action. The voltage oriented control technique is approached to solve this issue. The PWM converter is current regulated with the direct axis current is being used to regulate the DC link voltage where as the quadrature axis current component is used to regulate the reactive power.

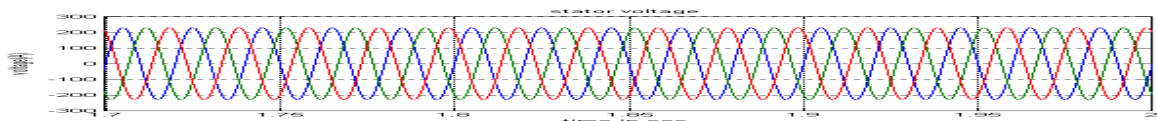

Fig.11. Stator voltage waveform

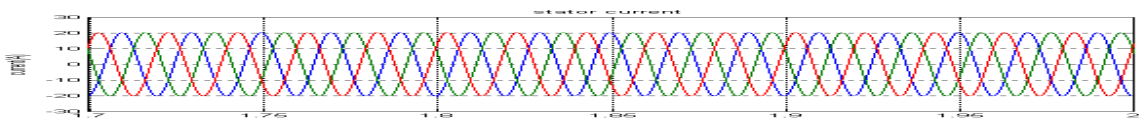

Fig.12. Stator current waveform

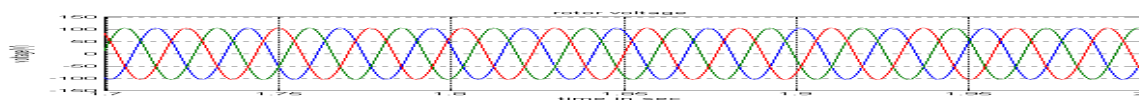

Fig.13. Rotor voltage waveform

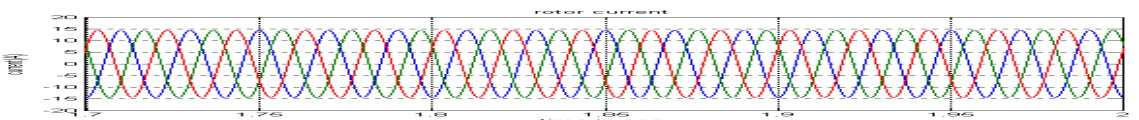

Fig.14. Rotor current waveform

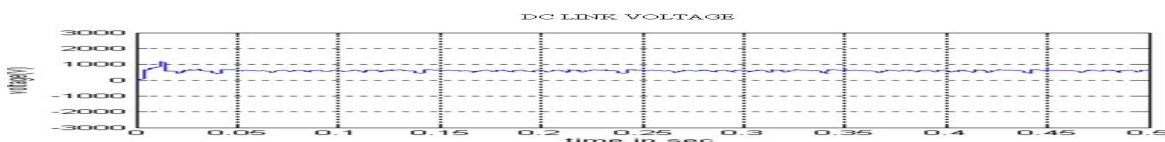

Fig.15. DC-Link voltage output waveform

International Journal of Advanced Research in Electrical, Electronics and Instrumentation Engineering

(An ISO 3297: 2007 Certified Organization)

Vol. 3, Special Issue 2, April 2014

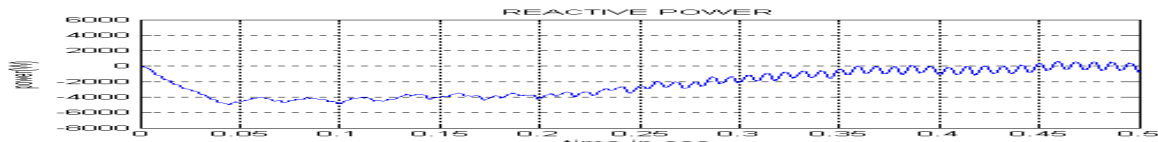

Fig.16. Reactive power output waveform

4.3 SIMULATION RESULTS FOR REFERENCE CURRENT GENERATION CONTROL SCHEME

The main objective of the grid side converter is to maintain dc-link voltage constant for necessary action. The reference current generation control technique is approached to solve this issue. The PWM converter is current regulated with the generation of reference current is being used to regulate the DC link voltage for balanced supply condition by using p-q theory is also used to regulate the reactive power.

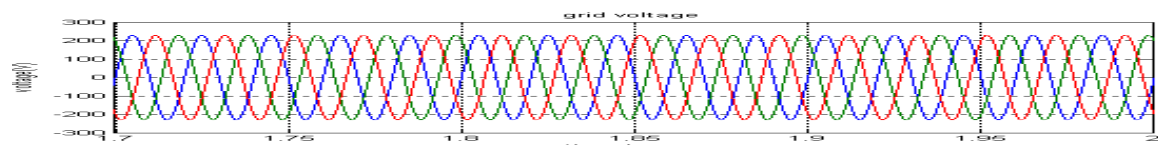

Fig.17. Grid voltage waveform

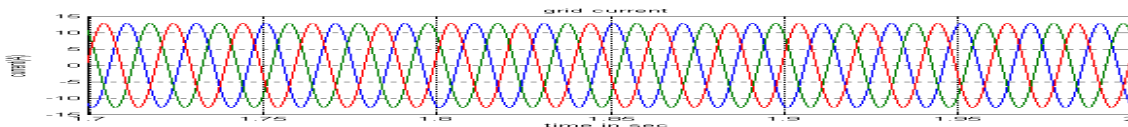

Fig.18. Grid current waveform

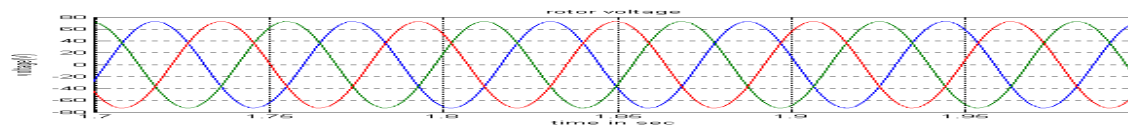

Fig.19. Rotor voltage waveform

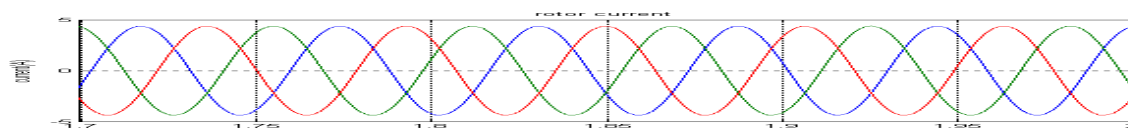

Fig.20. Rotor current waveform

TABULATION FOR VARIOUS SPEED

S. NO	SPEED (rpm)	STATOR POWER(W)	ROTOR POWER(W)	DC LINK VOLTAGE (V)
1	1145.9	-987	83	600
2	1336.9	-1385	240	600
3	1623.3	-2983	-252	600
4	1718.8	-3550	-510	600



International Journal of Advanced Research in Electrical, Electronics and Instrumentation Engineering

(An ISO 3297: 2007 Certified Organization)

Vol. 3, Special Issue 2, April 2014

V CONCLUSION

Detailed models of the DFIG have been analyzed with required parameters and their generating mode of operation is explained clearly with help of waveforms obtained from simulation results. The various response of the system are observed in both super and sub-synchronous generating mode of operation. The control scheme of machine-side converter and grid-side converter has been simulated by using MATLAB/SIMULINK.

VI. APPENDIX

DOUBLY FED INDUCTION GENERATOR RATING

Power	4000 (W)
Frequency	50 (Hz)
Voltage	400 (V)
Stator resistance	1.405 (ohm)
Rotor resistance	1.395 (ohm)
Stator and Rotor inductance	0.005839 (H)
Mutual inductance	0.1722 (H)
Moment of inertia	0.0131 (Kg.m ²)
Friction coefficient	0.002985
Pole pair	2

REFERENCES

- [1]. ManasiPatnaik, "Study Of Doubly Fed Induction Generator For Variable Speed Wind Energy Conversion Systems", *Special Issue Of International Journal Of Power System Operation and Energy Management*, ISSN (PRINT):2231–4407, Vol – 1, Issue – 3.
- [2]. F. Poitiers, M. Machmoum, R. Le Doeuff and M.E. Zaim, "Control Of A Doubly-Fed Induction Generator For Wind Energy Conversion System", *GE44-LARGE ,Ecolepolytechnique de l'universite`de Nantes, Saint Nazaire, France*.
- [3]. R. Pena, J.C Clare and G.M Asher, "Doubly Fed Induction Generator Using Back -to-Back PWM Converter and Its Application To Variable-Speed Wind Energy Generation", *IEEE Proceeding Electrical Power Application.*, Vol.143, NO.3, May1996, ISSN.,PP. 231-241.
- [4]. T. Thiringer, A. Petersson, and T. Petru , "Grid Disturbance Response Of Wind Turbine Equipped With Induction Generator and Doubly-Fed Induction Generator", in *Proceeding IEEE Power Engineering Society General Meeting*, Vol.3, Toronto, Canada, July 2003,pp.1542-47.
- [5]. A. Petersson, L. Harnefors, and T.Thiringer, "Evaluation Of Current Control Methods For Wind Turbines Using Doubly-Fed Induction Machine", *IEEE Transaction on Power Electrnocs.*, Vol 20, No.1, Jan 2005, PP.227-235
- [6]. CarlesBatlle , ArnauD`oria-Cerezo ,Romeo Ortega , "A Robustly Stable PI Controller For The Doubly-Fed Induction Machine" ,*IEEE Industrial Electronics*, *IECON 2006 – 32nd Annual Conference on 6-10 Nov. 2006*.
- [7].BrahimNait-Kaci, MamadouL.Doumbia, *Member IEEE*, KodjoAgbossou, *Senior Member IEEE* and AbderahmanYousif, "Active And Reactive Power Control Of A Doubly Fed Induction Generator For Wind Applications", *eurocon 2009 ,eurocon `09.IEEE*.
- [8]. Mahmoud Abdel HalimSalehy and Mona NaguibEskander, "Sub-Synchronous Range Of Operation For A Wind Driven Double-Fed Induction Generator", *Journal of power Electronics*, Vol.10, No. 1, January 2010.