

# Design Approach For Pitch Axis Stabilization of 3-Dof Helicopter System an LQR Controller

M.Bharathi, Golden Kumar

Professor and Head, Department of E&I, Bharath University, Chennai – 600073, India

Dept. of E&I, Bharath University, Chennai – 600073, India

**Abstract:** In this project an attempt has been made to adopt an LQR controller design approach for PITCH axis stabilization of 3DOF Helicopter System. The presentation in this report is not limited to only design a controller for the stabilization of PITCH axis model of 3DOF Helicopter but at same time it shows good performance. Some useful basic control systems concept related to Riccati equation, controllability of the system and PID controller have been also presented to understand the content of the project. The report first develops a transfer function and state space model to represent the PITCH axis dynamics of 3DOF Helicopter system and then LQR controller design steps are explained in brief.

The investigated state feedback controller design technique is an optimal design method and it is directly applicable to unstable pitch axis model of 3DOF Helicopter.

To show the effectiveness of the investigated method, the report also demonstrates the comparative studies between LQR and PID controllers. The results of the closed loop system performance with LQR controller and PID controller separately are also shown.

## 1.INTRODUCTION

3DOF Helicopter System (shown in Fig. 1.1) is composed of the base, leveraged balance, balancing blocks, propellers and some other components. Balance posts to base as its fulcrum, and the pitching. Propeller and the balance blocks were installed at the two ends of a balance bar. The propeller rotational lift, turning a balance bar around the fulcrum so pitching moves, using two propeller speed difference, turning a balance bar along the fulcrum to do rotational movement. Balance the two poles installed encoder, used to measure the rotation axis, pitch axis angle, in the two propeller connecting rod installed an encoder, which is used to measure overturned axis angle. Two propellers using brushless DC motors, provide the impetus for the propeller. By adjusting the balance rod installed in the side of the balance blocks to reduce propeller motor output. All electrical signals to and from the body are transmitted via slip ring thus eliminating the possibility of tangled wires and reducing the amount of friction and loading about the moving axes. Preparation of the experimental guidance on the purpose is to tell users how to design a controller, to control the helicopter in accordance with the desired angle and speed of movement.

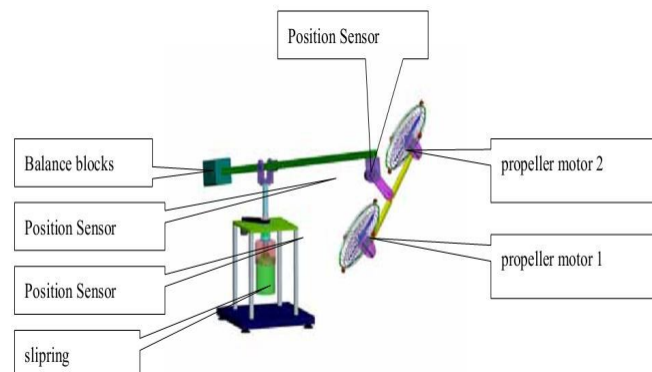

Figure 1.1: 3 DOF Helicopter systems

The theory of optimal control is concerned with operating a dynamic system at minimum cost. The case where the system dynamics are described by a set of linear differential equation and the cost is described by a quadratic functional called LQ problem, one of the main results in the theory is that solution is provided by the LQR, a feedback controller. First, we make

a detail analysis and modeling on 3DOF helicopter from its mechanism and features and get its modeling motion equations by the knowledge of physics. From the analysis of the model, the system is with the problem of non-linear and state interference. First, we get the linear state space through linearity of the system, and then we use the theory of LQR to get the optimal state feedback controller from the linear state space.

**1.2 Motivation**

The motivation for doing this project was primarily an interest in undertaking a challenging project in an interesting area of research. I found the 3DOF Helicopter system as an appropriate area of research of my interest, and using LQR controller design methods for checking its controllability and robustness was my contribution in this research paper. LQR controller is usually used in industry especially in chemical process and aerospace industry. LQR problem is one of the most fundamental and challenging control problems and in this method; controller is very easy to design and also increases the accuracy of state variable by estimating the state. It takes care of the tedious work done by the control system engineers in optimizing the controllers. However the engineer needs to specify the weighting factor and compare the result with the specified desired goals. This means that the controller synthesis is an iterative process, where the engineer judges to produce optimal controllers through simulation and computation and then adjusts the weighting factor to get a controller more in line with the specified design goals this computing and simulation work for controller synthesis, motivated us to work on this project.

**1.3 Objectives**

Design and simulation of LQR controller for pitch axis stabilization of 3 DOF helicopter system (using MATLAB).

**II. MATHEMATICAL MODELLING**

It is composed of the base, leveraged balance, balancing blocks, propellers and some other components. Balance posts to base as its fulcrum, and the pitching. Propeller and the balance blocks were installed at the two ends of a balance bar.

The propeller rotational lift, turning a balance bar around the fulcrum so pitching moves, using two propeller speed difference, turning a balance bar along the fulcrum to do rotational movement. Balance the two poles installed encoder, used to measure the rotation axis, pitch axis angle, in the two propeller connecting rod installed an encoder, which is used to measure overturned axis angle.

Two propellers, using brushless DC motors, provide the impetus for the propeller. By adjusting the balance rod installed in the side of the balance blocks to reduce propeller motor output. All electrical signals to and from the body are transmitted via slip ring thus eliminating the possibility of tangled wires and reducing the amount of friction and loading about the moving axes.

Three differential equations to describe the dynamics of the system. A simple set of differential equations is developed as follows:

**2.1 Pitch axis**

Consider the diagram in Fig.2.1 Assuming the roll is zero, then the pitching axis torque by two propeller motors lift the F1 and F2. Therefore, the pitch propeller axis total lift  $F_h = F_1 + F_2$ . When the lift  $F_h$  is greater than the gravity  $G$  Helicopter rise. Instead the helicopter dropped. Now, assuming zero roll, the differential equation is:

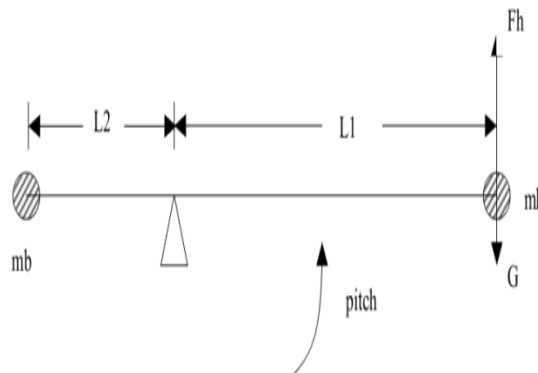

**Figure 2.1: Pitch axis dynamics**

$$J_e \ddot{\theta} = l_1 F_h - l_1 G = l_1 (F_1 + F_2) - l_1 G \tag{2.1}$$

$$J_e \ddot{\theta} = K_c l_1 (V_1 + V_2) - T_g = K_c l_1 V_s - T_g \tag{2.2}$$



Where,

$J_e$  is the moment of inertia of the system about the pitch axis,  $J_e = m_h l_1^2 + m_b l_2^2$ .

$m_b$  is the mass of balance blocks.

$m_h$  is the total mass of two propeller motor.

$V_1$  and  $V_2$  are voltages applied to the front and back motors resulting in force  $F_1$  and  $F_2$ .

$K_c$  is the force constant of the motor /propeller combination.

$l_1$  is the distance from the pivot point to the propeller motor.

$l_2$  is the distance from the pivot point to the balance blocks. Ignoring  $T_g$  in equation 3.2.2 we get

$$J_e \ddot{\epsilon} = K_c l_1 V_s \quad (2.3)$$

Now, Taking Laplace transform of (2.2.3) we get:

$$J_e S^2 \epsilon(s) = K_c l_1 V_s(s)$$

$$\frac{\epsilon(s)}{V_s(s)} = \frac{K_c l_1}{J_e S^2}$$

Substituting the value of  $k_c = 12 \text{ N/V}$ ,  $l_1 = 0.88 \text{ m}$ ,  $j_e = 1.8145 \text{ kg.m}^2$  in the above equation, we can get the transfer function of 3 DOF helicopter system.

$$\frac{\epsilon(s)}{V_s(s)} = \frac{5.82}{s^2}$$

This equation gives the pitch transfer function of 3 DOF.

### 2.2 State Space Modelling of Pitch axis for 3DOF:

We know that:

$$\dot{\epsilon} = \dot{\epsilon} \quad (2.10)$$

$$\dot{p} = \dot{p} \quad (2.11)$$

$$\ddot{\epsilon} = l_1 V_1 K_c / J_e + l_1 V_2 K_c / J_e \quad (2.12)$$

$$\ddot{p} = l_p V_1 K_c / J_p + l_p V_2 K_c / J_p \quad (2.13)$$

$$\dot{r} = G l_1 p / J_t \quad (2.14)$$

Assuming that :

$$\dot{\zeta} = \epsilon \quad (2.15)$$

$$\dot{\gamma} = r \quad (2.16)$$

Now we have to find A and B matrix for 3DOF Helicopter system using the above seven linear differential equation:

$$A = \begin{bmatrix} 0 & 0 & 1 & 0 & 0 & 0 & 0 \\ 0 & 0 & 0 & 1 & 0 & 0 & 0 \\ 0 & 0 & 0 & 0 & 0 & 0 & 0 \\ 0 & 0 & 0 & 0 & 0 & 0 & 0 \\ 0 & \frac{G l_1}{J_t} & 0 & 0 & 0 & 0 & 0 \\ 1 & 0 & 0 & 0 & 0 & 0 & 0 \\ 0 & 0 & 0 & 0 & 1 & 0 & 0 \end{bmatrix}$$

$$B = \begin{bmatrix} 0 & 0 \\ 0 & 0 \\ \frac{K_c l_1}{J_e} & \frac{K_c l_1}{J_e} \\ \frac{K_c l_p}{J_p} & -\frac{K_c l_p}{J_p} \\ 0 & 0 \\ 0 & 0 \\ 0 & 0 \end{bmatrix}$$

So we have the linearized equation of above state-space A and B as:

$$\begin{bmatrix} \dot{\epsilon} \\ \dot{p} \\ \ddot{\epsilon} \\ \ddot{p} \\ \dot{r} \\ \dot{\zeta} \\ \dot{\gamma} \end{bmatrix} = A \begin{bmatrix} \epsilon \\ p \\ \dot{\epsilon} \\ \dot{p} \\ r \\ \zeta \\ \gamma \end{bmatrix} + B \begin{bmatrix} V1 \\ V2 \end{bmatrix}$$

### III. RESERACH METHODOLOGY

#### 3.1 LQR controller design method

The LQR optimal control principle is, by system equations:

$$\dot{X} = AX + Bu$$

Determine matrix K that gives the optimal

$$\text{Control vector: } u(t) = -K \cdot x(t)$$

Such that the performance index is minimized:

$$J = \int_0^{\infty} (X' Q X + u' R u) dt$$

In which Q is positive definite (or semi-positive definite) hermitian or real symmetric matrix R is positive definite hermitian or real symmetric matrix.

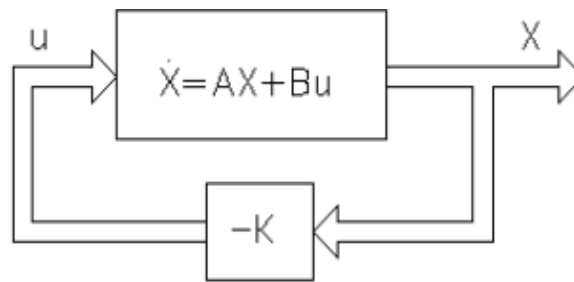

Fig. 3.1: Optimal LQR controller diagram

The second term on the right of the equation is introduced in concern of energy loss. Matrix Q and R determine the relative importance of error and energy loss. Here, it is assumed that the control vector u(t) is unbounded.

#### Weighting Matrices selection

One way of expressing the performance index mathematically is through an objective function of this form:

$$J = \int_0^{\infty} x^T Q x dt + \int_0^{\infty} u^T R u dt$$

For Simplicity we assume Q and R as Diagonal matrix. Thus the Objective J reduces to :

$$J = q_1 x_1^2 + \dots + q_n x_n^2 + r_1 u_1^2 + \dots + r_m u_m^2$$

Here, the Scalars  $q_1, \dots, q_n, r_1, \dots, r_m$  can be looked upon as relative weights between different performance terms in the objective J. The key design problem in LQR is to translate performance specifications in terms of the rise time, overshoot, bandwidth, etc. into relative weights of the above form. There is no straightforward way of doing this and it is usually done through an iterative process either in simulations or on an experimental setup. Once the matrices Q and R are completely specified, the controller gain K is found by solving the **Riccati equation**.

$$\begin{bmatrix} R & 0 \\ 0 & U_2^{-2} \end{bmatrix} \quad (3.1)$$

$U_1$  and  $U_2$  are the maximum acceptable value of the input voltages. And matrix Q can be found using **Bryson's rule**:

$$Q = \begin{bmatrix} q_{11} & 0 & 0 & 0 & 0 & 0 & 0 \\ 0 & q_{22} & 0 & 0 & 0 & 0 & 0 \\ 0 & 0 & q_{33} & 0 & 0 & 0 & 0 \\ 0 & 0 & 0 & q_{44} & 0 & 0 & 0 \\ 0 & 0 & 0 & 0 & q_{55} & 0 & 0 \\ 0 & 0 & 0 & 0 & 0 & q_{66} & 0 \\ 0 & 0 & 0 & 0 & 0 & 0 & q_{77} \end{bmatrix}$$

Where according to **Bryson’s rule**:

- Q<sub>11</sub> is 1/ maximum acceptable value of (pitch angle)<sup>2</sup>
- Q<sub>22</sub> is 1/ maximum acceptable value of (roll angle)<sup>2</sup>
- Q<sub>33</sub> is 1/ maximum acceptable value derivative of (pitch angle)<sup>2</sup>
- Q<sub>44</sub> is 1/ maximum acceptable value of derivative of (roll angle)<sup>2</sup>
- Q<sub>55</sub> is 1/ maximum acceptable value of (travel rate)<sup>2</sup>
- Q<sub>66</sub> is 1/ maximum acceptable value of (damping ratio)<sup>2</sup>
- Q<sub>77</sub> is 1/ maximum acceptable value of (□)<sup>2</sup>

Substituting the above values:

$$Q =$$

### 3.2 PID controller design approachpitch axis of 3DOF Helicopter system

The PID control scheme is named after its three correcting terms, whose sum constitutes the manipulated variable. The proportional, integral, and derivative terms are summed to calculate the output of the PID controller.

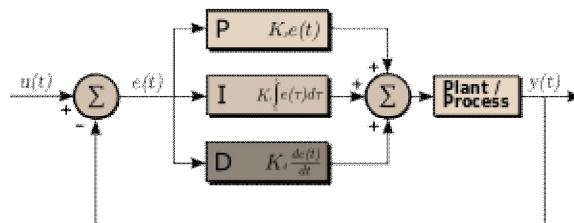

**Figure 3.2: PID controller**

As seen in Fig.2.2 the different terms associated with the controller and its operations are being explained in detail below. The block contains the three different parameters namely Proportional, Integral and derivative. The final form of the PID algorithm is:

$$u(t) = K_p e(t) + K_i \int e(t) dt + K_d \frac{de(t)}{dt} \tag{3.0}$$

Where,  $K_p$  =Proportional Gain,  $K_i$  =Integral Gain,  
 $K_d$  =Derivative Gain,  $e$  =Error,  $t$  =Instantaneous time

#### Proportional term

The proportional term produces an output value that is proportional to the current error value. The proportional response can be adjusted by multiplying the error by a constant called the proportional gain constant. A high proportional gain results in a large change in the output for a given change in the error. If the proportional gain is too high, the system can become unstable.

#### Integral Term

The contribution from the integral term is proportional to both the magnitude of the error and the duration of the error. The integral in a PID controller is the sum of the instantaneous error over time and gives the accumulated offset that should have been corrected previously. The accumulated error is then multiplied by the integral gain and added to the controller output. The integral term eliminates the residual steady-state error that occurs with a pure proportional controller.

#### Derivative Term

The derivative of the process error is calculated by determining the slope of the error over time and multiplying this rate of change by the derivative gain. The magnitude of the contribution of the derivative term to the overall control action is termed the derivative gain. The derivative term slows the rate of change of the controller output. Derivative control is used to reduce the magnitude of the overshoot produced by the integral component and improve the combined controller-process stability.

#### Pitch PID Controller

The Pitch axis model is given by equation (2.3):

Where,  $V_1 + V_2 = V_s$

We design the PID controller of the form as follows:

$$V_s = K_{ep}(\varepsilon - \varepsilon_c) + K_{ed}\dot{\varepsilon} + K_{ei} \int (\varepsilon - \varepsilon_c) (3.1)$$

$\varepsilon$  is the actual pitch angle,  $\varepsilon_c$  is the desired pitch angle

Now substituting the values we get:

$$J_e \varepsilon'' = K_{cl1} [K_{ep}(\varepsilon - \varepsilon_c) + K_{ed}\dot{\varepsilon} + K_{ei} \int (\varepsilon - \varepsilon_c)] (3.2)$$

Taking Laplace transform, the closed loop Transfer function is given by :

$$J_e \varepsilon(s) \cdot s^2 = K_{cl1} K_{ep} \varepsilon(s) - K_{cl1} K_{ep} \varepsilon_c(s) + K_{cl1} K_{ed} \cdot s \cdot \varepsilon(s) + \frac{K_{cl1} K_{ei} (\varepsilon - \varepsilon_c)}{s}$$

$$\frac{\varepsilon(s)}{\varepsilon_c(s)} = \frac{K_{cl1} K_{ep} \cdot s + K_{cl1} K_{ei}}{J_e s^3 - K_{cl1} K_{ed} s^2 - K_{cl1} K_{ep} \cdot s - K_{cl1} K_{ei}} (3.3)$$

#### IV.RESULTANALYSIS

##### 4.1 Controllability of the system

A system is said to be controllable at time t, if it is possible by means of an unconstrained control vector to transfer the system from any initial state x(t) to any other state in a finite interval of time. In fact, the conditions of controllability may govern the existence of a complete solution to the control system design problem. The solution to this problem may not exist if the system considered is not controllable. Although most physical systems are controllable, corresponding mathematical models may not possess the property of controllability. Then it is necessary to know the conditions under which a system is controllable.

##### 4.1.1 Complete State Controllability of Continuous-Time Systems:

Consider the continuous-time system.

$$\dot{X} = AX + Bu \quad (4)$$

Where:

x = state vector (n-vector), u = control signal (scalar),

A = n X n matrix, B = n X 1 matrix

The system described by Equation (4.0) is said to be state controllable at t = to if it is possible to construct an unconstrained control signal that will transfer an initial state to any final state in a finite time interval to  $t_0 \leq t \leq t_1$ . If every state is controllable, then the system is said to be completely state controllable.

We now derive the condition for complete state controllability. Without loss of generality, we can assume that the final state is the origin of the state space and that the initial time is zero.

The solution of equation (4.0) is:

$$X(t) = e^{At} X(0) + \int_0^t e^{A(t-\tau)} Bu(\tau) d\tau (4.1)$$

$$X(t_1) = 0 = e^{At_1} X(0) + \int_0^{t_1} e^{A(t_1-\tau)} Bu(\tau) d\tau$$

Or, We know that:

$$X(0) = - \int_0^{t_1} e^{-A\tau} Bu(\tau) d\tau \quad (4.3)$$

$$e^{-A\tau} = \sum_{k=0}^{n-1} \alpha_k(\tau) A^k \quad (4.4)$$

Substituting the equation (4.4) in (4.3) we get:

$$X(0) = - \sum_{k=0}^{n-1} A^k B \int_0^{t_1} \alpha_k(\tau) u(\tau) d\tau (4.5)$$

$$\text{Let us put, } \int_0^{t_1} \alpha_k(\tau) u(\tau) d\tau = \beta_k$$

The equation (4.5) becomes:

$$X(0) = - \sum_{k=0}^{n-1} A^k B \beta_k$$

$$= - [B: AB: \dots : A^{n-1}B] \begin{bmatrix} \beta_0 \\ \vdots \\ \beta_{n-1} \end{bmatrix} \quad (4.6)$$

If the system is completely state controllable, then, given any initial state x(0), This requires that the rank of the n X n matrix be 'n'.

$$[B: AB: \dots : A^{n-1}B]$$

From this analysis, we can state the condition for complete state controllability as follows: The system given by Equation (4.0) is completely state controllable if and only if the vectors B, AB, . . . . A<sup>n-1</sup>B are linearly independent, or the n X n matrix is of rank n.



[B: AB: ... : A<sup>n-1</sup>B]

The result just obtained can be extended to the case where the control vector u is r-dimensional. If the system is described by

$$\dot{X} = AX + Bu$$

Where u is an r-vector, then it can be proved that the condition for complete state controllability is that the  $n \times nr$  matrix.

[B: AB: ... : A<sup>n-1</sup>B]

B of rank n, or contain n linearly independent column vectors. The matrix

[B: AB: ... : A<sup>n-1</sup>B]

is commonly called the **Controllability** matrix.

**Controllability for Pitch axis dynamic model of 3 DOF Helicopter system**

We have a state space model of the helicopter system as follows:

$$A = \begin{bmatrix} 0 & 0 & 1 & 0 & 0 & 0 & 0 \\ 0 & 0 & 0 & 1 & 0 & 0 & 0 \\ 0 & 0 & 0 & 0 & 0 & 0 & 0 \\ 0 & 0 & 0 & 0 & 0 & 0 & 0 \\ 0 & 2.0655 & 0 & 0 & 0 & 0 & 0 \\ 1 & 0 & 0 & 0 & 0 & 0 & 0 \\ 0 & 0 & 0 & 0 & 1 & 0 & 0 \end{bmatrix}$$

$$B = \begin{bmatrix} 0 & 0 \\ 5.8197 & 5.8197 \\ 63.9498 & -63.9498 \\ 0 & 0 \\ 0 & 0 \\ 0 & 0 \end{bmatrix}$$

Using MATLAB the controllability matrix of the system is obtained, M=

$$M = \begin{bmatrix} 0 & 0 & 5.8197 & 5.8197 & 0 & 0 & 0 & 0 & 0 & 0 & 0 & 0 & 0 & 0 \\ 0 & 0 & 63.9498 & -63.9498 & 0 & 0 & 0 & 0 & 0 & 0 & 0 & 0 & 0 & 0 \\ 5.8197 & 5.8197 & 0 & 0 & 0 & 0 & 0 & 0 & 0 & 0 & 0 & 0 & 0 & 0 \\ 63.9498 & -63.9498 & 0 & 0 & 0 & 0 & 0 & 0 & 0 & 0 & 0 & 0 & 0 & 0 \\ 0 & 0 & 0 & 0 & 132.0883 & -132.0833 & 0 & 0 & 0 & 0 & 0 & 0 & 0 & 0 \\ 0 & 0 & 0 & 0 & 5.8197 & 5.8197 & 0 & 0 & 0 & 0 & 0 & 0 & 0 & 0 \\ 0 & 0 & 0 & 0 & 0 & 0 & 132.0833 & -132.0833 & 0 & 0 & 0 & 0 & 0 & 0 \end{bmatrix}$$

The rank of the above matrix M is 7 which is equal to order of the system matrix A<sup>[MATLAB]</sup>.

**Therefore the system is controllable.**

**4.2 Open loop response for pitch axis**

The differential equation for pitch axis dynamics from equation (2.3) is given by:

$$J_e \ddot{\epsilon} = K_c l_1 (V_1 + V_2) - T_g = K_c l_1 V_s - T_g$$

Ignoring T<sub>g</sub> in the above equation we get:

$$J_e \ddot{\epsilon} = K_c l_1 V_s$$

Now, Taking Laplace transform of we get:

$$J_e S^2 \epsilon(s) = K_c l_1 V_s(s)$$

$$\frac{\epsilon(s)}{V_s(s)} = \frac{K_c l_1}{J_e S^2}$$

Substituting the value of  $k_c=12N/V, l_1=0.88m, j_e=1.8145kg.m^2$  in the above equation, we can get the transfer function of 3 DOF helicopter system. Finally the open loop transfer function is:

$$\frac{\epsilon(s)}{V_s(s)} = \frac{5.82}{S^2}$$

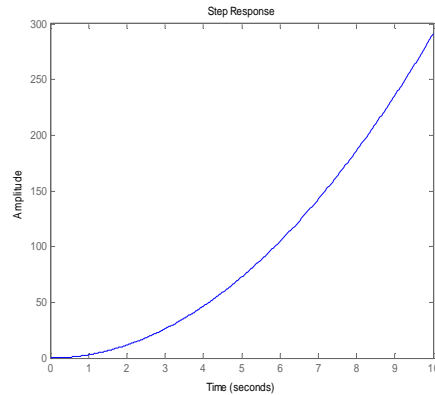

Figure 4.1: Open loop response

The Pitch axis model of Helicopter system is unstable as it gives unbounded output for the bounded input signal. It is shown in the figure 4.1

**4.3 State feedback controller of Pitch axis model for Helicopter system:**

The plant state space model is already explained in section 2.2.4 and it follows that

$$A = \begin{bmatrix} 0 & 0 & 1 & 0 & 0 & 0 & 0 \\ 0 & 0 & 0 & 1 & 0 & 0 & 0 \\ 0 & 0 & 0 & 0 & 0 & 0 & 0 \\ 0 & 0 & 0 & 0 & 0 & 0 & 0 \\ 0 & \frac{Gl_1}{J_t} & 0 & 0 & 0 & 0 & 0 \\ 1 & 0 & 0 & 0 & 0 & 0 & 0 \\ 0 & 0 & 0 & 0 & 1 & 0 & 0 \end{bmatrix}$$

$$B = \begin{bmatrix} 0 & 0 \\ 0 & 0 \\ \frac{K_c l_1}{J_e} & \frac{K_c l_1}{J_e} \\ \frac{K_c l_p}{J_p} & -\frac{K_c l_p}{J_p} \\ 0 & 0 \\ 0 & 0 \\ 0 & 0 \end{bmatrix}$$

The weighting matrices Q & R are selected based on the theory which is explained in the section 3.1. The Matrices Q and R are finally chosen by the equations 3.1 and 3.2.

$$Q = \begin{bmatrix} 51.0204 & 0 & 0 & 0 & 0 & 0 & 0 \\ 0 & 4.1649 & 0 & 0 & 0 & 0 & 0 \\ 0 & 0 & 1.0129 & 0 & 0 & 0 & 0 \\ 0 & 0 & 0 & 0.5609 & 0 & 0 & 0 \\ 0 & 0 & 0 & 0 & 0.1014 & 0 & 0 \\ 0 & 0 & 0 & 0 & 0 & 11.1100 & 0 \\ 0 & 0 & 0 & 0 & 0 & 0 & 4.000 \end{bmatrix}$$



$$R = \begin{bmatrix} 0.01 & 0 \\ 0 & 0.01 \end{bmatrix}$$

Now using the MATLAB command:  $[K \ S \ E] = LQR(A, B, Q/1000, \text{and } R)$ , the state feedback gain matrix and closed loop pole of the system are given by the matrices  $K$  and  $E$  respectively:  $K = \begin{bmatrix} 1.8596 & 0.8379 & 0.6084 & 0.2028 & 0.6066 & 0.7453 & 0.4472 \\ 1.8596 & -0.8397 & 0.6084 & -0.2028 & -0.6066 & 0.7453 & -0.4472 \end{bmatrix}$

$$E = [-3.3070 + 2.7595i; -3.3070 - 2.7595i; -0.4676; -21.2420; -2.8192; -0.9415 + 1.0423i; -0.9415 - 1.0423i]$$

Here, all the closed loop poles (Eigen values) of the system are either lying in the left half of the s-plane or on the imaginary axis, therefore our designed system is stable.

Natural frequency and damping ratio of the closed loop system is also found using MATLAB code:  $[Wn, Z, P] = damp(A - B * K)$  and we found that response for the 2<sup>nd</sup> order system for each value of natural frequency ( $Wn$ ) and damping factor ( $Z$ ) are acceptable. It is shown in the following figure.

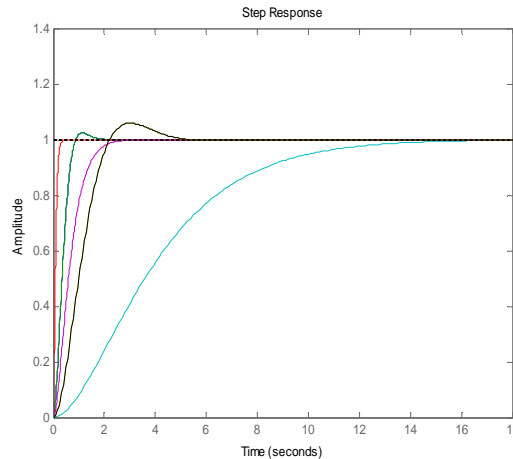

Figure 4.2: Response for diff. Wn and Z

#### 4.4 Pitch PID Controller using the values of state feedback gain K

The state feedback gain matrix  $K$  is given by [Section 4.3]

$$K = \begin{bmatrix} 1.8596 & 0.8379 & 0.6084 & 0.2028 & 0.6066 & 0.7453 & 0.4472 \\ 1.8596 & -0.8397 & 0.6084 & -0.2028 & -0.6066 & 0.7453 & -0.4472 \end{bmatrix}$$

And we can also write the above Matrix  $K$  as:

$$K = \begin{bmatrix} K_{11} & K_{12} & K_{13} & K_{14} & K_{15} & K_{16} & K_{17} \\ K_{21} & K_{22} & K_{23} & K_{24} & K_{25} & K_{26} & K_{27} \end{bmatrix}$$

And full state feedback results in a controller those feedback two voltages:

$$\begin{bmatrix} V_1 \\ V_2 \end{bmatrix} = - \begin{bmatrix} K_{11} & K_{12} & K_{13} & K_{14} & K_{15} & K_{16} & K_{17} \\ K_{21} & K_{22} & K_{23} & K_{24} & K_{25} & K_{26} & K_{27} \end{bmatrix} x$$

$$K = \begin{bmatrix} K_{11} & K_{12} & K_{13} & K_{14} & K_{15} & K_{16} & K_{17} \\ K_{11} & -K_{12} & K_{13} & -K_{14} & -K_{15} & K_{16} & -K_{17} \end{bmatrix}$$

$V_1 + V_2 = -2k_{11}(\varepsilon - \varepsilon_c) - 2k_{13}\dot{\varepsilon} - 2k_{16}\zeta(4.7)$  Now comparing the result with equation (3.1):

$$V_s = V_1 + V_2 = K_{ep}(\varepsilon - \varepsilon_c) + K_{ed}\dot{\varepsilon} + K_{ei} \int (\varepsilon - \varepsilon_c)$$

Now comparing the above two equations, the gains we obtain from LQR design can still be used for pitch controller as follows:

$$K_{ep} = -2K_{11} = -3.7192$$

$$K_{ed} = -2K_{13} = -1.2168$$

$$K_{ei} = -2K_{16} = -1.4096$$

#### 4.4.1 Simulation results

Using equation 3.3 the closed loop transfer function of the system is given by:

$$\frac{\varepsilon(s)}{\varepsilon_c(s)} = \frac{K_c l_1 K_{ep} s + K_c l_1 K_{ei}}{J e s^3 - K_c l_1 K_{ed} s^2 - K_c l_1 K_{ep} s - K_c l_1 K_{ei}}$$

Now, substituting the values  $K_c=12, l_1=0.88, J_e= 1.8145, K_{ep}= -3.7192, K_{ed}= -1.2168$  and  $K_{ei}= -1.4906$ , we got:

$$\frac{\varepsilon(s)}{\varepsilon_c(s)} = \frac{39.2748s + 15.7407}{1.8145s^3 - 12.8494s^2 - 39.2748s - 15.7407}$$

The above transfer function is obtained using extracted values  $K_{ep}, K_{ei}$  and  $K_{ed}$  from designed state feedback gain matrix  $K$  as explained in section 4.3.

The response of the above closed loop transfer function is obtained and it is shown in figure 4.3.

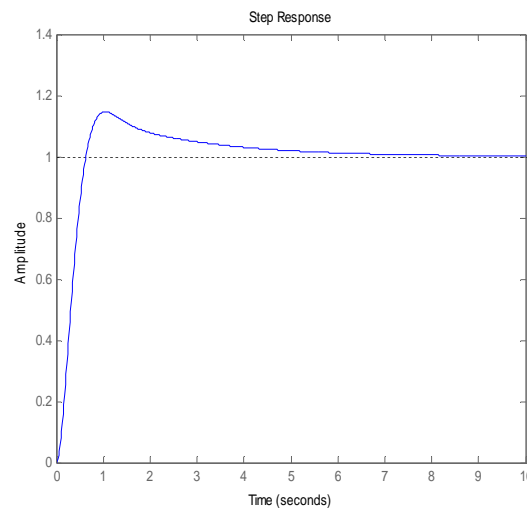

Figure 4.3: Designed closed loop system response

Now, substituting the values  $K_c=12$ ,  $I_1=0.88$ ,  $J_c= 1.8145$ ,  $K_{ep}= -2.0852$ ,  $K_{cd}= -0.8698$  and  $K_{ci}= -0.2$ , we get:

$$\frac{\varepsilon(s)}{\varepsilon_c(s)} = \frac{22.0197s+2.1120}{1.8145s^3-9.1851s^2-22.0197s-2.1120}$$

The response of the above closed loop transfer function is obtained and it is shown in figure 4.4.

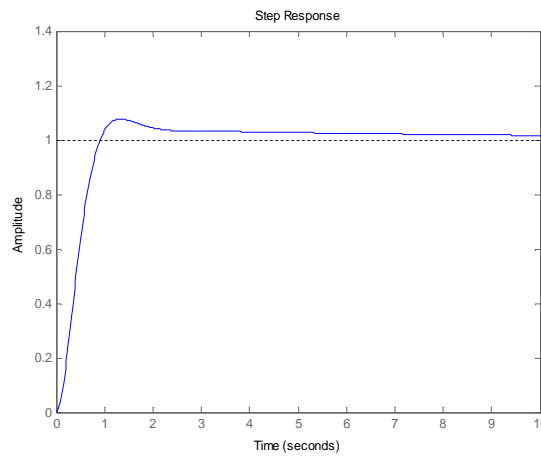

Figure4.4: Closed loop system response for reference PID value

4.4.2 Real time system response

The real time simulation is done using Helicopter PID control diagram [6]

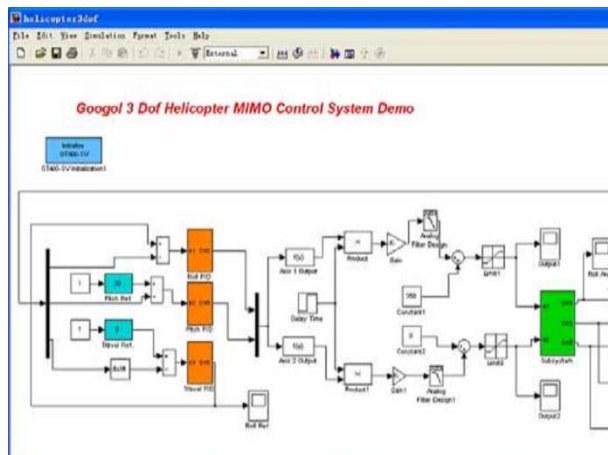

Figure 4.5:3DOF Helicopter MATLAB Real Time Control Diagram  
 Double click the “Pitch PID” block to set pitch PID parameters.

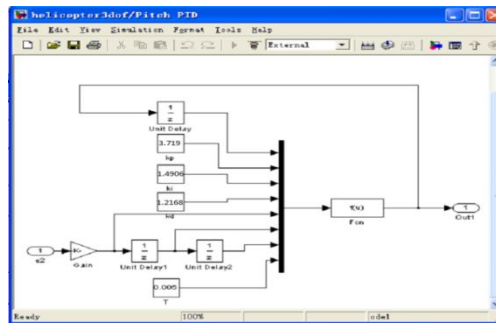

Figure 4.6: Pitch PID block diagram

Double click the “Kp” block to set proportional parameter of pitch PID as the simulation results, and double click “OK” to save parameters.

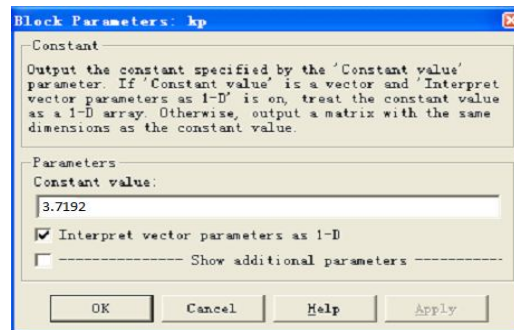

Figure 4.7: K<sub>p</sub> Block

Double click the “Ki” block to set integral parameter of pitch PID as the simulation results, and double click “OK” to save parameters

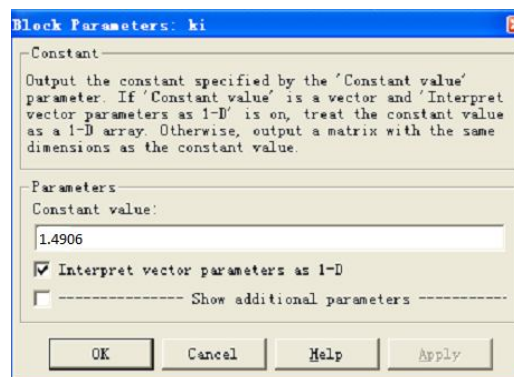
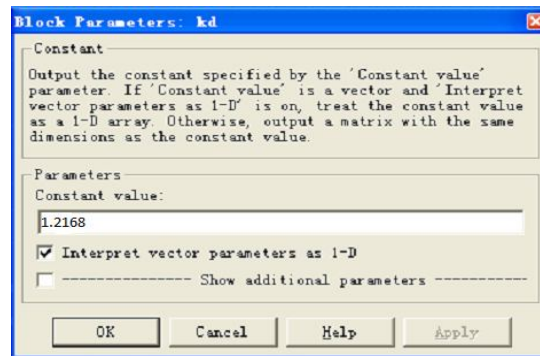

Figure 4.8: K<sub>i</sub> Block

Double click the “Kd” block to set derivative parameter of pitch PID as the simulation results, and double click “OK” to save parameters.



**Figure 4.9:K<sub>d</sub> Block**

Case 1: System response for 35 degrees (reference) pitch angle

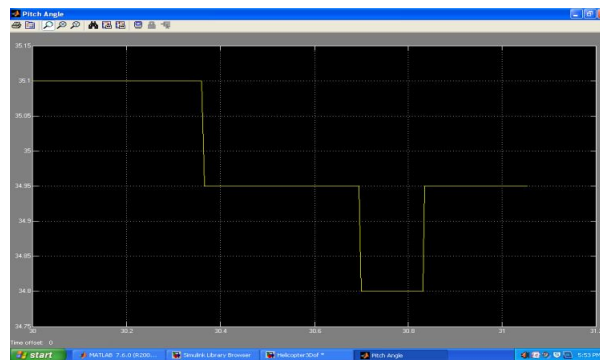

**Figure 4.10: Tracking for 35 degree**

**Result:** We found that system is stable and tracking the reference input successfully.

Case 2: System response for 45 degrees:

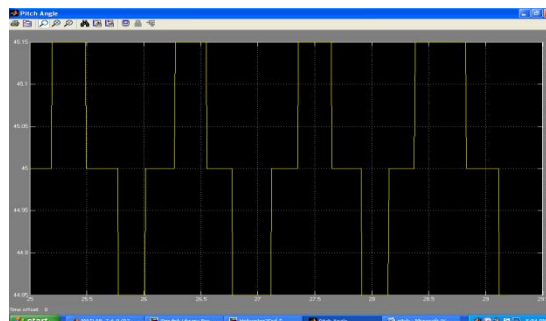

**Figure 4.11: Tracking for 45 degrees**

**Result:** In this case also system is stable and tracking the input signal.

Case 3: System response for 55 degrees:-

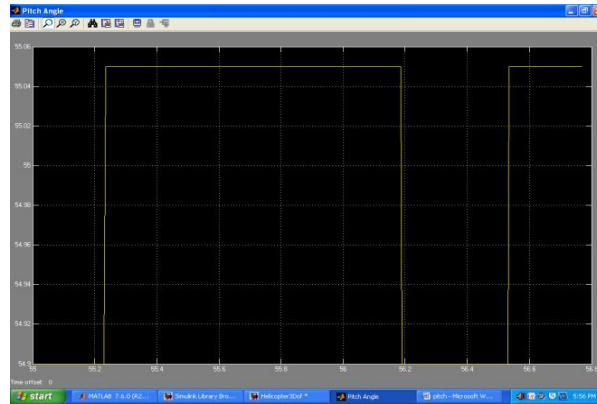

**Figure 4.12: Tracking for 55 degrees**  
**Result: The system is stable and tracking the reference signal.**

#### 4.6 Comparative studies between LQR and PID controllers

The PID controller parameters  $K_p$ ,  $K_d$  and  $K_i$  have been found using LQR state feedback gain matrix  $K$  [section 4.3] and then closed loop system performance analysed. The following time domain performance parameters are obtained.

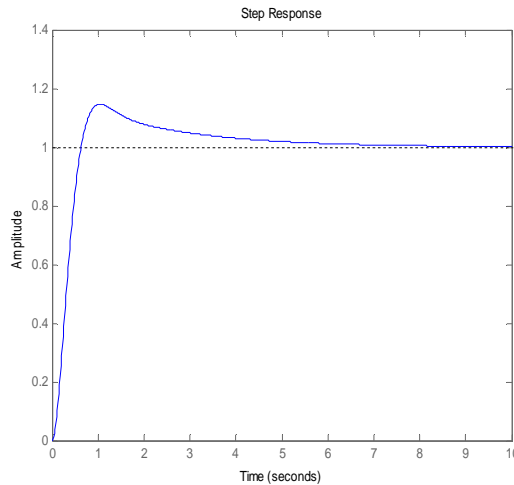

**Figure 4.13: Designed closed loop response**

RiseTime: 0.4291s, Settling Time: 4.8948s, Overshoot: 14.6289%, Peak: 1.1463, Peak Time: 1.0470s

Again we have taken PITCH PID controller values and closed loop system response obtained which is shown in the figure

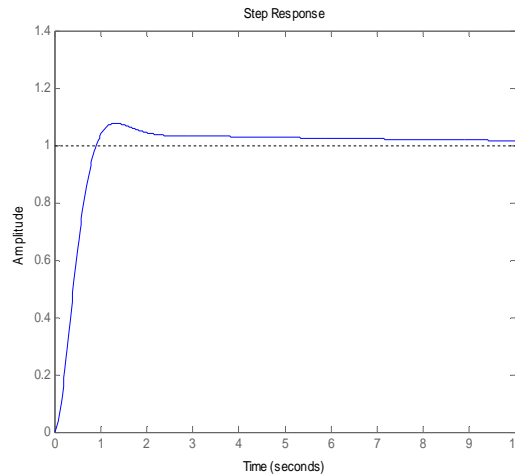

**Figure 4.14: Closed loop response of reference PID values**

Rise Time:0.6021s,Settling Time:7.9956s,Overshoot: 7.6368%Peak: 1.0764,Peak Time: 1.3321s

## V.CONCLUSION AND FUTURE SCOPE OF WORK

### 5.1 Conclusion

In this project an optimal design approach has been chosen to design a state feedback controller for PITCH axis model of 3DOF Helicopter system. First we developed the Mathematical model of 3DOF Helicopter system and then stability & performance of the modelled system is carried out.

The theory of LQR controller design has been investigated and a different approach based on Bryson rule has been also adopted to select the weighting matrices which are used in controller synthesis.

The selected project is also demonstrated successfully in real time platform and it is followed by the comparison with existing design. Simulation analysis is also shown in the report.

### 5.2 Future Work:

In this project an LQR controller is synthesized for PITCH axis stabilization for 3 DOF helicopter systems and the same approach can be extended for Travel and Roll axes for the same system.

## REFERENCES

- [1] Li Qing, Yin Xiuyun, Liu Zhengao and Fanfan, "Construction of helicopter loop simulation system and model identification", ICEMI 2007
- [2] Pei-Ran Li, TaoShen, "The research of 3DOF Helicopter tracking control", August 2007
- [3] MariyaA.Ishutkina, "Design and Implementation of supervisory safety controller for 3DOF Helicopter system", MIT, June 2004
- [4] Bo Zheng and YishengZhong, "Robust attitude regulation of 3DOF helicopter benchmark", IEEEfeb 2011.
- [5] David G. Hill, "Optimal control theory for application", Springer, 2004
- [6] Technical Manual-3DOF Helicopter Systems, GOOGOL TECH, 2011
- [7] Robert W. Newcomb, "Optimal control theory", 1970
- [8] Katsuhiko Ogata, Modern Control engineering", 2010
- [9] Peter Whittle, "Optimal Control –Basic & Beyond, John Wiley & Sons, 1996
- [10] Frank L. Lewis, "Applied Optimal Control &Estimation, PHI, 1988