



Speed Control of Three Phase Induction Motor Using Fuzzy Logic Controller by Space Vector Modulation Technique

V.Vengatesan¹, M.Chindamani²

PG Student [PED], Dept. of EEE, Sri Ramakrishna Engineering College, Coimbatore, Tamilnadu, India¹

Assistant Professor, Dept. of EEE, Sri Ramakrishna Engineering College, Coimbatore, Tamilnadu, India²

ABSTRACT: For electrical drives good dynamic performance is mandatory so as to respond to the changes in command speed and torque. This requirement of AC drives can be fulfilled by the vector control method which enables the control of field and torque of induction motor independently (decoupling) by manipulating corresponding field oriented quantities. The traditional indirect vector control system uses conventional PI controller in the outer speed loop because of the ease and constancy, unexpected change in load conditions or environmental factors produce overshoot, fluctuation of motor speed, oscillation of the torque and long settling time causes deterioration of drive performance. An intelligent controller based on Fuzzy Logic can be used in the place of PI regulator to overcome. In this paper application of fuzzy logic to the intelligent SVPWM based speed control of induction motor drive is investigated. To solve the objective of this paper MATLAB/ SIMULINK software is used. The superior control performance of the proposed controller is demonstrated at SIMULINK platform using the fuzzy logic tool box.

KEYWORDS: Fuzzy logic control, Indirect Field Oriented Control, Space Vector Pulse Width Modulation, Induction motor.

I.INTRODUCTION

In recent years, the field oriented control of induction motor drive is widely used in high performance drive system, because of its advantages like high efficiency, very simple, extremely rugged, good power factor. Induction motor is used in many applications such as Industrial drives, automotive control, etc. In the modern years there has been a great demand in industry for adjustable speed drives.

The Space Vector Pulse Width Modulation (SVPWM) method is an advanced, computation-intensive PWM method and best among all the PWM techniques. Because of its superior performance characteristics, it has been finding well-known application in recent years. The Pulse Width Modulation methods discussed so far have only considered implementation on half bridges operated independently, giving suitable Pulse Width Modulation methods performance. With a machine load, the load neutral is normally isolated, which causes interface among the phases. This interface was not considered before in the Pulse Width Modulation discussion.

Recently, Fuzzy logic control has found many applications in the past decade. FLC has proven effective for complex, non-linear and inaccurately defined processes for which standard model based control techniques are impractical or impossible. Fuzzy controller deals with problems that have imprecision, ambiguity and use membership functions with values varying between 0 and 1. This means that if the reliable practiced knowledge is not available or if the controlled system is too difficult to derive the required decision rules, development of a FLC become time consuming and sometimes impossible. In the case that the practiced knowledge is available, fine-tuning of the controller might be time consuming as well. Furthermore, an optimal FLC cannot be achieved by trial-and-error. These drawbacks have limited the application of fuzzy logic control. Some difficult tasks have been made to solve these problems and simplify the task of tuning parameters and developing rules for the controller. These approaches mainly use adaptation or learning techniques drawn from artificial intelligence or neural network theories.

II. BLOCK DIAGRAM OF SPEED CONTROL OF THREE PHASE INDUCTION MOTOR USING FUZZY LOGIC CONTROLLER BY SPACE VECTOR MODULATION TECHNIQUE

The proposed block diagram of fuzzy logic controller based induction motor drive consists of rectifier, filter, inverter, fuzzy logic controller and the induction motor. The three phase controlled rectifier converts the three phase AC supply into DC supply which consists of some ripple content which can be eliminated using the filter, the inverter block converts the DC supply into the AC to supply power to the three phase induction motor. The motor speed is sensed and the sensed actual speed ($\omega_r(n)$) and the motor reference speed ($\omega_r^*(n)$) are compared. The speed error $\Delta\omega_r(n)$ and change in speed error $\Delta e(n)$ is given as the input to the fuzzy logic controller and the output of the FLC is the Electromagnetic torque (T_e^*) and the quadrature-axis stator current reference (i_{qs}^*) is calculated from electromagnetic torque (T_e^*) equation (1). The flux component of current (i_{ds}^*) for the desired rotor flux is (Ψ_r^*) determined from equation (2), the variation of magnetizing inductance (L_m) will cause some drift in the flux. The slip frequency (ω_{sl}) is generated from i_{qs}^* in feed forward manner from equation (5), signal (ω_{sl}) is added with speed signal ω_r to generate frequency signal (ω_e). The unit vector signal $\cos \theta_e$ and $\sin \theta_e$ are generated from ω_e by integration, command current i_{qs}^* and i_{ds}^* in the vector control are compared with the respective i_{qs} and i_{ds} currents generated by transformation of phase current equation (6) with help of unit vector (θ_e). The respective error generate the voltage command signal V_{qs}^* and V_{ds}^* through P-I compensators and these voltage commands are then converted into $V_{\alpha s}$ and $V_{\beta s}$ voltages, these voltages are given to the input of SVPWM. The outputs of the Space vector pulse width modulation are the signals that drive the inverter. Among various modulation techniques for inverter, SVPWM technique is an attractive technique which directly uses the control variable given by the control system and identifies each switching vector as a point in complex space. The current model generates the rotor flux position and is dependent on the rotor time constant ($\tau_r = \frac{L_r}{R_r}$). The proposed block diagram is shown in the fig.1.

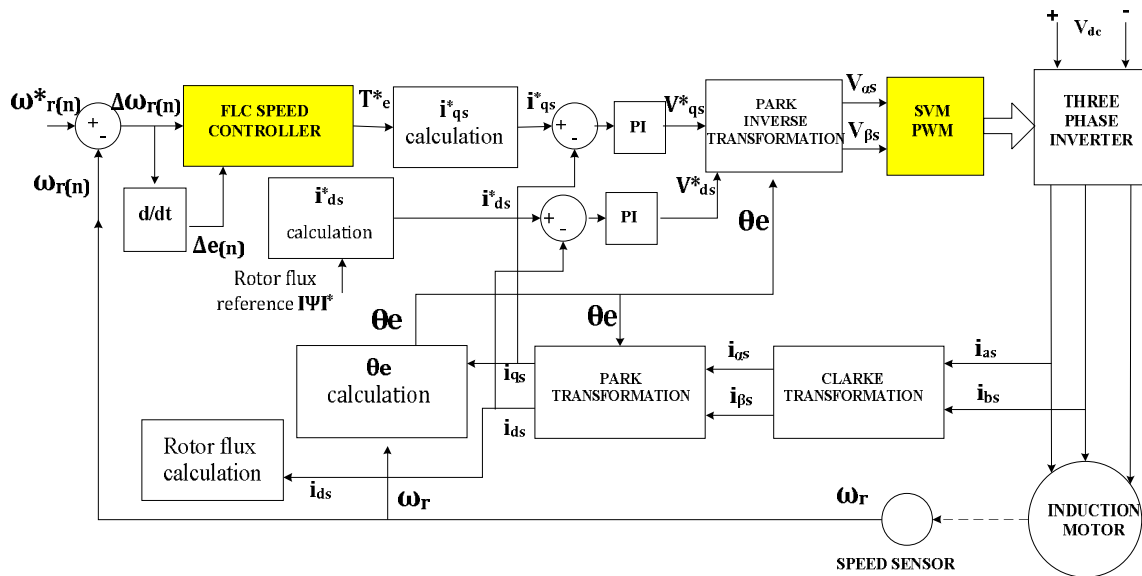

Fig.1 Block diagram for Fuzzy logic controller of IM speed control by SVPWM technique

A. PRINCIPLE OF FIELD-ORIENTED CONTROL:

The construction of a DC machine is such that the field flux and armature flux are perpendicular to each other. Being orthogonal, these two fluxes produce no net interaction on one another. Adjusting the field current we can control the DC machine flux, and by adjusting armature current torque can be controlled independently. Because of interactions between the stator and rotor fields an AC machine is not so simple in which orientations are not held at 90 degrees. DC machine-like performance can be obtain in holding a fixed and orthogonal orientation between the field and armature fields in an AC machine. To attain independently controlled flux and torque by orientation of the stator current with respect to the rotor flux, such a control scheme is called flux-oriented control or vector control and it is applicable to both induction and synchronous motors.

International Journal of Advanced Research in Electrical, Electronics and Instrumentation Engineering

(An ISO 3297: 2007 Certified Organization)

Vol. 3, Issue 12, December 2014

1. The induction motor is fed by a voltage source SVPWM inverter. The motor speed ω is compared with the reference speed ω^* and the error is produced which is fed to the speed controller. The output of speed controller is electromagnetic torque T_e^* .

2. The quadrature-axis stator current reference i_{qs}^* is calculated from electromagnetic torque reference T_e^* as

$$i_{qs}^* = \left(\frac{2}{3}\right) \left(\frac{2}{p}\right) \left(\frac{L_r}{L_m}\right) \left(\frac{T_e^*}{\widehat{\psi}_r}\right) \quad (1)$$

Where $\widehat{\psi}_r = |\psi_r|_{est}$ is the estimated value of rotor flux linkage given by

$$\widehat{\psi}_r = \left(\frac{L_m i_{ds}}{1 + \tau_r s}\right) \quad (2)$$

Where, $\tau_r = \left(\frac{L_r}{R_r}\right)$ is the rotor time constant

3. The direct-axis stator current reference i_{ds}^* is obtained from reference rotor flux input $|\psi_r|^*$.

$$i_{ds}^* = \left(\frac{|\psi_r|^*}{L_m}\right) \quad (3)$$

4. The rotor flux position θ_e required for coordinates transformation is obtained from the rotor speed ω_r and slip frequency ω_{sl} . θ_e calculated as

$$\theta_e = \int (\omega_r + \omega_{sl}) dt = \theta_r + \theta_{sl} \quad (4)$$

5. The slip frequency is calculated from the stator reference current i_{qs}^* , and the motor parameters.

$$\omega_{sl} = \left(\frac{L_m R_r}{\psi_r L_r}\right) i_{qs}^* \quad (5)$$

The transformation of the three-phase (abc-axis) current components of an induction motor to the equivalent two-phase (dq-axis) current components can be performed by

$$\begin{bmatrix} I_{qs} \\ I_{ds} \end{bmatrix} = \frac{2}{3} \begin{bmatrix} \sin\theta_e & \sin\left(\theta_e - \frac{2\pi}{3}\right) & \sin\left(\theta_e + \frac{2\pi}{3}\right) \\ \cos\theta_e & \cos\left(\theta_e - \frac{2\pi}{3}\right) & \cos\left(\theta_e + \frac{2\pi}{3}\right) \end{bmatrix} \begin{bmatrix} I_{as} \\ I_{bs} \\ I_{cs} \end{bmatrix} \quad (6)$$

The three-phase current components i_{as} , i_{bs} , and i_{cs} are in stationary reference frame which does not rotate in space whereas the two phase current components i_{ds} , i_{qs} are in the synchronous reference frame whose direct and quadrature axes rotate in space at the synchronous speed.

B.PRINCIPLE OF SPACE VECTOR MODULATION:

The concept of space vectors is derived from modulating the inverter output voltage from the rotating field of AC. In this technique the three phase quantities can be transformed to their equivalent 2-phase quantity either in synchronously rotating frame or stationary frame. From this 2-phase component the reference vector magnitude can be found and used for modulating the inverter output. By using active and zero space vectors the active and zero switching states can be determined. The space vector diagram for the three-level inverter is shown in the Fig.2 where the six active vectors V_1 to V_6 form a regular hexagon with six equal sectors (I to VI). The zero vector V_0 lies on the center of the hexagon. From this analysis, the space vector modulation task can be solved into following steps to make the actual PWM pattern.

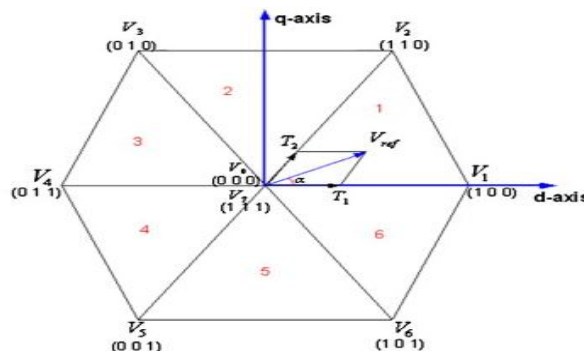

Fig.2.Sector Selection of Space Vector Modulation



International Journal of Advanced Research in Electrical, Electronics and Instrumentation Engineering

(An ISO 3297: 2007 Certified Organization)

Vol. 3, Issue 12, December 2014

Step 1: Sector Identification: By comparing the stationary frame d-q components of the reference voltage vector, the sector where the reference vector is located is identified.

Step 2: Calculating the Effective Timer: Using the d-q components of reference vector and the DC link voltage information, the effective times T1, T2 are calculated.

Step 3: Determining the switching Times: using the corresponding sector information the actual switching time for each inverter leg is generated from the combination of the effective times and zero sequence time.

C. CALCULATE REFERENCE (V_{ref}), ANGLE (α), & SWITCHING TIME:

This SVM calculates appropriate duty ratios needed to generate a given stator reference voltage (V_{ref}) using space vector PWM technique. The alpha and beta components ($V_{\alpha s}, V_{\beta s}$) are transformed via the inverse Park equation and projected into reference phase voltages. These voltages are represented in the outputs as the duty ratios of the SVPWM. Magnitude (length) and position, V_{ref} can be synthesized by three nearby stationary vectors, based on which the switching states of the inverter can be selected and gate signals for the active switches can be generated.

$$|V_{ref}| = \sqrt{(V_{\alpha}^2 + V_{\beta}^2)} \quad (7)$$

$$\alpha = \tan^{-1} \left(\frac{V_{\alpha}}{V_{\beta}} \right) \quad (8)$$

$$T_1 = T_z a \frac{(\sin \pi/3 - \alpha)}{\sin \pi/3} \quad (9)$$

$$T_2 = T_z a \frac{(\sin \alpha)}{\sin \pi/3} \quad (10)$$

$$T_0 = T_z - (T_1 + T_2) \quad (11)$$

D. DESIGN OF FUZZY LOGIC-BASED SPEED CONTROLLER

For the proposed FLC, the speed error and change of the speed error are considered as the input linguistic variables and the torque- producing current component is considered as the output linguistic variable. Thus, the functional relation of the FLC can be expressed as

$$i_q(n) = \int_{discrete} \Delta i_q(n) = f(\Delta e(n), \Delta \omega_r(n)) \quad (12)$$

where $\Delta e(n) = \Delta \omega_r(n) - \Delta \omega_r(n - 1)$ is the change of speed error, $\Delta \omega_r(n) = \omega_r^*(n) - \omega_r(n)$ is the present sample of speed error, $\Delta \omega_r(n - 1)$ is the post sample of speed error, $\Delta \omega_r(n)$ is the present sample of actual speed, $\omega_r^*(n)$ is the present sample of command speed, and f denotes the nonlinear function. The main goal of the control system is to track the command speed by providing the appropriate torque- producing current component i_q depending upon the operating conditions. In real time, the motor position information and output of the fuzzy, which is considered as the command q-axis current i_q^* , as well as the command d-axis current i_d , are compared to the quadrature current (i_q, i_d) to get the quadrature stator voltage (v_q^*, v_d^*). The electrical position of the motor can be expressed as

$$\theta_e = \int (\omega_r + \omega_{sl}) dt = \theta_r + \theta_{sl} \quad (13)$$

Where θ_e is rotating field position, θ_r is the rotor position due to slip speed and θ_{sl} is the slip position due to slip speed. In the next step, the scaling facto K_w, K_e, K_i are chosen for fuzzification, as well as for obtaining the actual output of the command current. The scaling factors play important role for the fuzzy logic controller. The factors $K_w, K_e, and K_i$ are chosen to normalize the speed error $\Delta \omega_n$ and change of speed error (Δe_n), respectively, so that these remain within the limit of ± 1 . Factor K_i is so chosen that one can get the rated current for rated conditions. Here, the constants are taken as $K_w = \omega_r^* \cdot K_e = 10$, and $K_i = 10$ in order to get the optimum drive performances. The membership function (MF) of $\Delta \omega_{rn}, \Delta e_n, and i_{qn}^*$ which perform the vital task of the fuzzy logic control is the next step after selecting the scaling factor. The MF used for the input and output fuzzy sets show in Fig 3,4,5. The trapezoidal function are used as membership function for all fuzzy sets except the fuzzy set ZE (zero) of input vectors. The trapezoidal membership functions are used for all fuzzy set ZE of the input vectors and all the fuzzy sets of the output vector. The trapezoidal membership function is used to reduce the computation for online implementation. For this study, Mamdani-type fuzzy inference is used. The values of the constants, MF, input, output variables of linguistic variables, and the rules used in

International Journal of Advanced Research in Electrical, Electronics and Instrumentation Engineering

(An ISO 3297: 2007 Certified Organization)

Vol. 3, Issue 12, December 2014

this study are selected by trial and error to obtain the optimum drive performances. In this study, the center of gravity defuzzification is used. Each of the inputs and the output contain membership functions with all these four fuzzy sets.

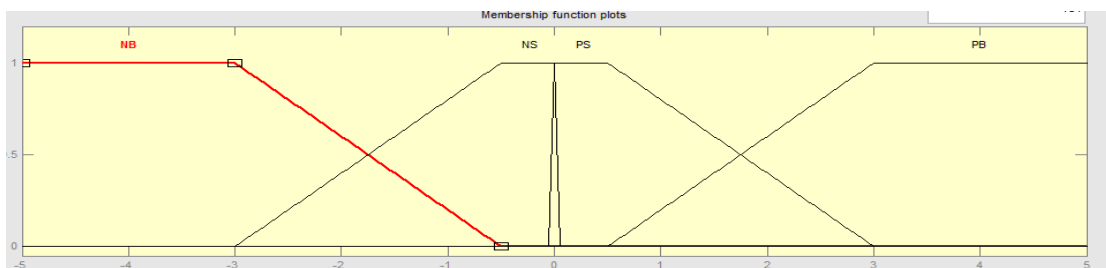

In the fig 3, it shows the fuzzy set and corresponding triangular MF description of speed error signal.

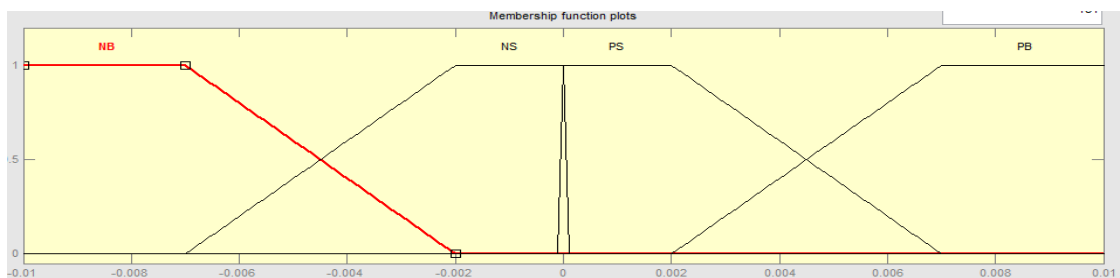

In the fig 4, it shows the fuzzy set and corresponding triangular MF description of change in speed error signal.

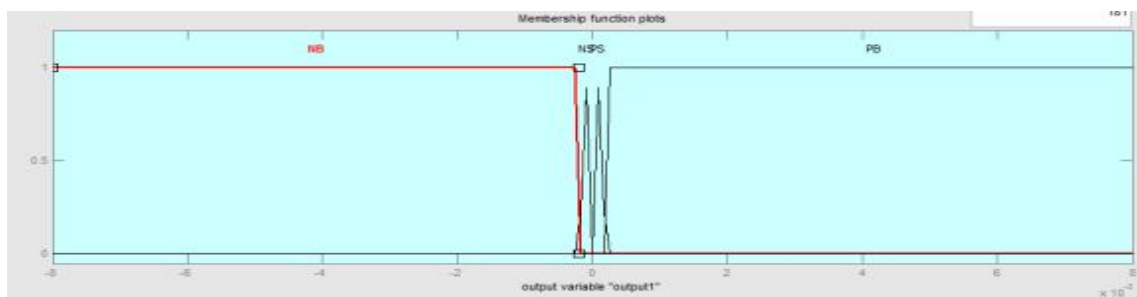

In the fig 5, it shows the fuzzy set and corresponding triangular MF description of output signal.

The fuzzy sets are defined as follows:

PS=Positive Small PB: Positive Big NS= Negative Small NB= Negative Big

The universe of discourse of all the variables, covering the whole region, is expressed in per unit values. All the MFs are asymmetrical because near the origin (steady state), the signals require more precision. There are four MFs for error and change of error signals, where as there are four MFs for output. All the MFs are symmetrical for positive and negative values of the variables. The mapping of the fuzzy inputs into the required output is derived with the help of a rule base as given in table.1.

Table 1 shows the corresponding rule table for the speed controller

CE/E	NB	NS	PS	PB
NB	PB	PS	NS	NB
NS	PB	PS	NS	NB
PS	NB	NS	PS	PB
PB	NB	NS	PS	PB

III. SIMULATION RESULTS

The simulation details of the three phase induction motor is explained .In this the proposed method SVPWM speed control strategy for induction motor drives is explained. The simulation of speed control of induction motor was done using the software package MATLAB/SIMULINK. For this purpose, the motor's block diagram, space vector modulation blocks are constructed using closed loop models .After running the closed loop model motor speed was analyzed.

A.OUTPUT CURRENT AND TORQUE CHARACTERISTIC:

The output current and torque response of IM drive using SVPWM technique is shown in the fig.6, fig.7.

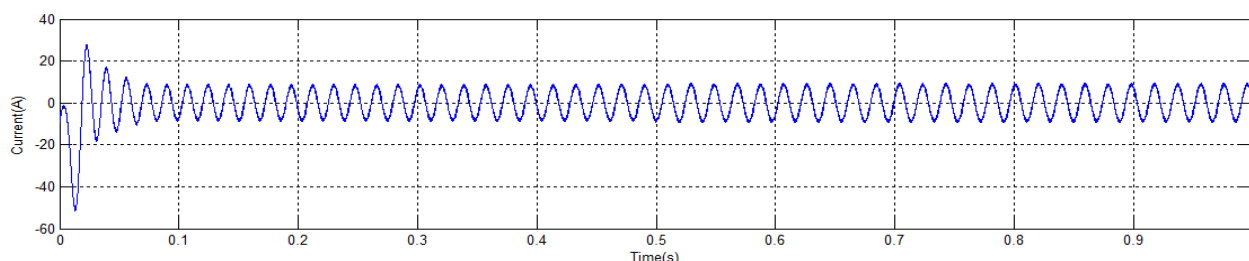

In the fig 6, it shows Output current characteristics of IM using FLC by SVPWM.

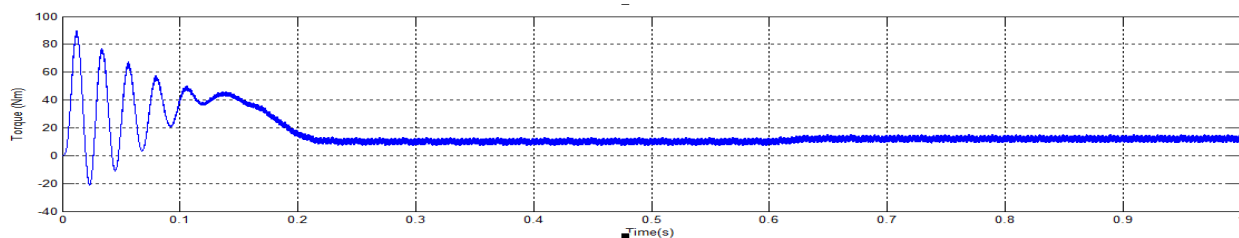

In the fig 7, it shows Output Electromagnetic Torque characteristics of IM using FLC by SVPWM.

B.OUTPUT SPEED CHARACTERISTIC:

The output speed response of IM drive using FLC by SVPWM technique is shown in the fig.9. & without FLC is shown in fig.8. In this paper rise time is less also the actual speed can be settled as fast as possible by using fuzzy logic controller.

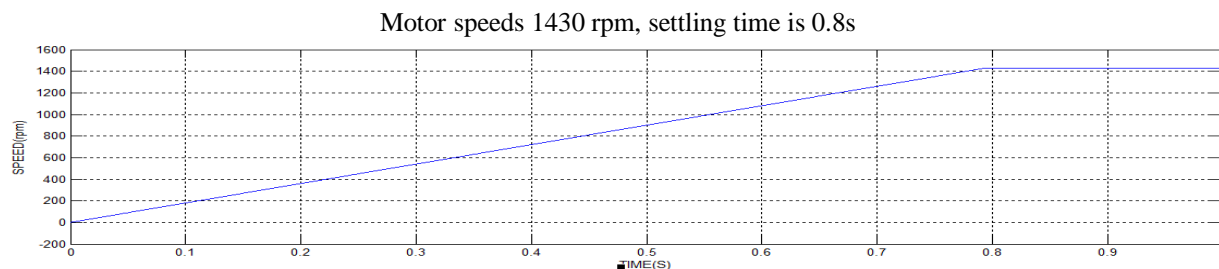

In the fig 9, it shows Output speed characteristics of IM using SVPWM, the actual speed is settled at 0.8s and the rise time is high.



International Journal of Advanced Research in Electrical, Electronics and Instrumentation Engineering

(An ISO 3297: 2007 Certified Organization)

Vol. 3, Issue 12, December 2014

Motor speeds 1430 rpm, settling time is 0.3s

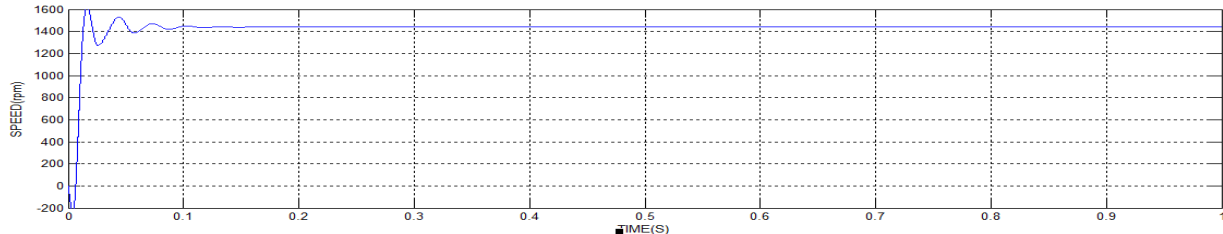

In the fig 9, it shows Output speed characteristics of IM using FLC with SVPWM technique, the actual speed is settled at 0.3s and the rise time is very less.

IV. CONCLUSION

Fuzzy logic controller based speed control of Induction Motor drive has been simulated using MATLAB. The simulated results show the improved performance of speed control of the Induction Motor by a SVPWM voltage-source inverter (VSI). The simulation results also show that the speed response of fuzzy controller with improved performance compare to SVPWM and conventional controller.

The parameters of the motor used for the simulation in MATLAB are shown in table 2.

Table.2 Induction motor parameters

PARAMETER	SYMBOL	RATING
Power rating	P_w	4kw
Rated voltage	V_s	400V
Rated speed	N_{rated}	1430rpm
Stator resistance	R_s	1.4 Ω
Stator inductance	L_s	0.0058H
Rotor resistance	R_r	1.3 Ω
Rotor inductance	L_r	0.0058H
No .of poles	P	4

REFERENCES

- [1] Bimal K. Bose, "Modern Power Electronics and AC Drives," Pearson education.
- [2] Novotny D.W., Lipo T.A., Vector control and dynamics of AC drives, Oxford University Press Inc., New York, 1996.
- [3] Bose B.K., "Power Electronics and Motion Control-Technology Status and Recent Trends." IEEE Transactions on Industry Applications, Vol. 29, no. 5., 1993.
- [4] Fonseca J., Afonso J.L., Martins J.S., Couto C., "Fuzzy Logic Speed Control of an Induction Motor," Microprocess. And Microsyst., Vol. 22, pp.523 - 534., 1999.
- [5] Mondal, S.K.; Bose, B.K.; Oleschuk, V.; Pinto, J.O.P., "Space vector pulse width modulation of three-level inverter extending operation into overmodulation region," IEEE Transactions on Power Electronics, Vol. 18, Issue 2, pp. 604 – 611, Mar. 2003.
- [6] Chitra V., Prabhakar R.S., "Induction Motor Speed Control Using Fuzzy Logic Controller," World Academy of Science, Engineering and Technology 23, 2006.
- [7] Erenoglu I., Eksin I., Yesil E., Guzelkaya M., "An intelligent hybrid fuzzy PID controller" Proceeding of the 20th European, Modeling and Simulation,(ECMS'06), Wolfgang Borutzky, Alessandra Orsoni, Richard Zobel, pp. 1-5, 2006.
- [8] Tunyasirut S., Suksri T., Srilad S., "Fuzzy logic control for a speed control of induction motor using space vector pulse width modulation" International Journal of Applied Science, Engineering and Technology, Vol. 4 No. 1, 2006.
- [9] Alfredo Munoz –Garcia, Thomas .A.Lipo, Donald. W.Novotony, "A New Induction motor V=f control method capable of High performance Regulation at low speeds," IEEE Transaction on Industry Applications, Vol. 34, No. 4, pp. 813-821, 1998.
- [10] Guang Feng, Yan-Fei Liu, and Lipei Huang, "Space A New Robust Algorithm to Improve the Dynamic Performance on the Speed Control of Induction Motor Drive," IEEE Transactions On Power Electronics, Vol. 19, No. 6, November 2004.
- [11] R.Arulmozhiyal, Dr.K.Baskaran, Speed Control of Induction Motor using Fuzzy PI and Optimization using GA, International Journal of Recent Trends in Engineering, Vol 2, No.5, and November, 2009.